

# **Basic Rider Optimization Training for the Segway™ Human Transporter (HT) i Series, e Series and p Series models**



**Instructor Guide and  
Participant Workbook**

## Important information for e Series users



### WARNING!

To reduce the risk of injury, all users of e Series models should first complete training provided by a Segway™ authorized trainer.

### The Segway HT e Series has all the same components as the Segway HT i Series, and the following additional components and features:

- > A Front Bag Frame and Front Bag
- > A Lower Cargo Structure
- > Two Side Bags
- > An electronic parking stand, called E-Stand, that enables the e Series to balance itself (“park”) without a rider

### Please follow these recommendations:

- > Charge your Segway HT for a full 12 hours before the first use.
- > Do not let anyone power on your Segway HT e Series Segway HT or try to engage or disengage E-Stand, unless that person has completed training, provided by a Segway authorized trainer
- > Don't let anyone step on or ride your e Series Segway HT unless that person has completed training, provided by a Segway authorized trainer
- > Install the Side Bags onto the Lower Cargo Structure prior to operation
- > Place approximately 10 lbs (4.5 kg) in each Side Bag prior to operation
- > When your Segway HT e Series is parked using E-Stand, make sure no one bumps, pushes, or leans on the Segway HT
- > To obtain training, or if you have any questions or if any injury incident occurs, call Segway at 1-866 4SEGWAY

# Notice

## Copyright © Segway LLC 2002. All rights reserved.

This Workbook (including all information contained in this Workbook) is copyrighted and protected by worldwide copyright laws and treaty provisions. This Workbook may contain other proprietary notices and copyright information that should be observed.

## Segway LLC Trademarks.

Segway LLC owns a number of trademarks used in this Workbook, including Segway™ and the Segway Flyer symbol. Failure of a mark to appear in this Workbook does not mean that Segway LLC does not use the mark, nor does it mean that the product is not actively marketed or is not significant within its relevant market.

## Disclaimer, Updates, Warnings, Safety.

The only warranties applicable to Segway LLC products are the limited warranties stated on the “Segway™ Human Transporter Limited Warranty” delivered with the products. Segway LLC makes no other express or implied warranty. Segway LLC does not warrant services. Segway LLC does not warrant this Workbook. This Workbook and the information stated herein is provided “as is” without any representation or warranty, express or implied, of any kind; including, but not limited to, warranties of merchantability, noninfringement, or fitness for any particular purpose. Some jurisdictions do not allow for the exclusion of implied warranties, so the above exclusions may not apply to you.

This Workbook may contain inaccuracies and typographical errors. Segway LLC assumes no liability for injury or damages suffered directly or indirectly as a result of any errors in this Workbook. Segway LLC may update this Workbook. Segway LLC will post notices of Workbook updates at [www.segway.com](http://www.segway.com). Before using this Workbook, the user must check for such updates.

If a user is in doubt as to how to use a Segway LLC product, the user should contact Segway LLC Technical Support at [www.segway.com](http://www.segway.com) or 1-866-473-4929 with any questions.

As with any transportation device, using a Segway Human Transporter (HT) exposes the user to risk of injury. Improperly using a Segway HT substantially increases the risk and also risks causing damage to the Segway HT. Users must comply with all warnings and instructions contained in this Workbook, and any other user materials provided by Segway LLC, and that may be issued by Segway LLC as updates. You can reduce that risk by following all the instructions and warnings in this Workbook, and by completing the training, but you cannot eliminate the risk. Remembering that this risk of injury always exists should cause you to be a more careful, safer rider.

The Segway HT's unique balancing ability and ease of use can lead you to become overconfident. If you exceed the ability of the Segway HT to balance, such as by riding over obstacles, uneven terrain, slippery surfaces, loose materials, or steep slopes, you can very quickly lose control, leading to collisions, falls, and injury. The Segway HT's balancing ability depends upon traction for its tires. If the tires lose traction, then the Segway HT will not be able to move as necessary to maintain balance. You must be very careful to make sure that both of the tires of the Segway HT always have adequate traction.

## If your instructor is not a Segway LLC employee, then the following paragraph applies:

Segway LLC provides this Workbook for use by employees of its commercial customers. The instructor who is delivering this Workbook to you and instructing this course is not an employee or agent of Segway LLC. Segway LLC has no control over the manner or methods used by that instructor to instruct you in the use of the Segway HT. Segway LLC is not liable for the acts or omissions of the instructor. If you prefer to receive instruction from a Segway LLC employee or if you have any question about the safe use of the Segway HT, contact Segway Customer Support at 1-866-4SEGWAY (1-866-473-4929).

Just as with any other transportation device, you must be mentally alert and free from physical impairment to safely ride a Segway HT. You must be able to continually monitor your surroundings and the terrain in front of you. You must be able to maintain your lateral (side-to-side) balance. You must be able to safely step on and step off. You must be able to comply with all the instructions and warnings in this Workbook. Do not attempt to ride the Segway HT if you are ill or if, for any other reason, you cannot continually monitor your surroundings and the terrain, maintain your lateral (side-to-side) balance, step on and step off, and comply fully with the instructions and warnings in this Workbook. If you have any doubt about your ability to ride the Segway HT safely, do not attempt to ride until you have discussed your doubts with the instructor and you and the instructor are satisfied that you can ride safely. Also, never forget that unexpected events can happen. A person, vehicle, pet or other animal, obstacle, or unexpected terrain could appear in front of you. You must always ride under control and be prepared to slow and stop.

**If any user discovers any error in this document, the user should notify Segway Customer Support at 1-866-473-4929.**

Segway LLC is a Delaware Limited Liability Company. • Printed in the U.S.A

*Segway Human Transporter (HT)  
Basic Rider Optimization Training  
Instructor Guide and Participant Workbook  
P/N 1707100001*

# Table of Contents

<b>&gt; Session 1 Course Overview .....</b>	<b>6</b>
Introduction .....	7
Agenda .....	8
Group Introductions .....	9
Summary .....	9
<b>&gt; Session 2 Specifications, Components, Theory of Operation .....</b>	<b>10</b>
Introduction .....	10
Objectives .....	10
Topics .....	10
Specifications .....	11
Components of the Segway HT .....	14
Theory of Operation .....	22
Summary .....	25
<b>&gt; Session 3 Demonstration, Guided Ride, Skills &amp; Drills .....</b>	<b>27</b>
Introduction .....	27
Objectives .....	28
Topics .....	28
Segway HT Model Comparison .....	29
Demonstration and Guided Ride .....	29
Riding Form .....	32
Parking Stand Deployment and Retraction (i Series only) .....	33
Using the Keys .....	33
Stepping On – i and p Series .....	33
Stepping On – e Series .....	34
Turning .....	36
Loading and Unloading Cargo (e Series only) .....	36
Drills .....	37
Display Messages .....	42
Display Colors .....	42
Normal Operation .....	43
Error Conditions During Startup .....	43
Reduced Performance Levels .....	44
Critical Faults During Balance .....	45
System Faults .....	46
Display ID .....	47
Summary .....	49
<b>&gt; Session 4 Safety Features .....</b>	<b>50</b>
Introduction .....	50
Objectives .....	50
Topics .....	50
Overview of Product Design and Safety Features .....	50
Redundant Systems .....	50
Speed Limiter .....	52
Stick Shake Warning .....	55
Rider Detection .....	56
Safety Shutdown .....	58
Torque and Traction .....	59
Effect of Tire Pressure .....	60
Summary .....	60

<b>&gt; Session 5 Agility Track – Riding Skills .....</b>	<b>62</b>
Introduction .....	62
Objectives .....	62
Topics .....	62
Before You Ride .....	62
Agility Track .....	63
Summary .....	66
<b>&gt; Session 6 Maintenance and Service .....</b>	<b>67</b>
Introduction .....	67
Objectives .....	67
Topics .....	67
Segway HT Maintenance .....	67
Cleaning and Exposure to Water .....	68
If Your Mat Sticks to the HT Platform .....	68
Tire Pressure .....	68
Batteries .....	68
Replacing User-Serviceable Parts .....	73
Replacing the Battery Packs .....	75
Replacing a Tire/Wheel Assembly .....	76
Replacing the Mat .....	77
Securing or Replacing the Front Trim .....	77
Replacing the Fender .....	78
Replacing a Parking Stand (i Series only) .....	79
Replacing the Handlebar/Control Shaft Assembly .....	80
Replacing the Fixed Grip .....	81
Replacing the Steering Grip .....	82
Replacing the Charge Port Cover .....	83
Replacing the Control Shaft Clamp .....	84
Installing an Upper Frame and Bag Cargo Structure .....	85
Post-repair Checklist .....	86
Lifting and Loading Your Segway HT .....	86
Packing Your Segway HT for Shipment .....	86
Summary .....	87
<b>&gt; Session 7 Demonstrating and Guiding a Ride .....</b>	<b>88</b>
Introduction .....	88
Objectives .....	88
Topics .....	88
Tips and Techniques .....	88
Demonstrating a Ride .....	89
Guiding a Ride .....	89
Challenging Situations .....	90
Demonstration and Guided Ride Workshop .....	91
Summary .....	93
<b>&gt; Session 8 Course Summary .....</b>	<b>94</b>
Topics .....	94
Ride Outside (Optional) .....	94
Review Goals .....	95
Evaluations .....	95
<b>&gt; Session 9 Written and Riding Assessments .....</b>	<b>96</b>
Overview .....	96
Written Assessment .....	97
Riding Assessment .....	105

## > Session 1 Course Overview

### Instructor Planning Information

Key: **Black = Participant Information**  
Grey = Instructor Information

### Tasks and Material Checklist

- Training room reserved
- Reminder email to participants/ 1-day prior to training
- Segway HTs charged
- Tape and easel paper
- Name tags
- Cones, markers, and terrain features for agility track
- Helmets
- Wrist guards, knee and elbow pads (if applicable)
- Power cords
- White board and dry erase markers
- First-aid kit
- Basic Rider Participant Workbooks and Evaluation Forms
- Demo & Guide Workshop booklets
- Basic Rider Assessment Booklets and Answer Sheet
- Sign-in form
- Acknowledgements of completion (certificates)
- Agility track props and any necessary tools (screw driver, tape, double stick tape, screws/bolts, etc.)
- 2.5, 3, 4 and 5mm hex wrenches, T-20 six lobed wrench, 16mm deep socket, torque wrench with a range up to and including 50 Newton Meters (N-m)
- Course Expectations document, emailed in advance including expectation that riders will bring their own helmets
- Appropriate clothing recommendations for this training (comfortable clothing, flat shoes)
- Communicate information regarding medical conditions that may affect balance:

Just as with any other transportation Segway HT, you must be mentally alert and free from physical impairment to safely ride a Segway HT. You must be able to continually monitor your surroundings and the terrain in front of you. You must be able to maintain your lateral (side-to-side) balance. You must be able to safely step on and step off. You must be able to comply with all the instructions and warnings in this Workbook. Do not attempt to ride the Segway HT if you are ill or if, for any other reason, you cannot continually monitor your surroundings and the terrain, maintain your lateral (side-to-side) balance, step on and step off, and comply fully with the instructions and warnings in this Workbook. If you have any doubt about your ability to ride the Segway HT safely, do not attempt to ride until you have discussed your doubts with the instructor and you and the instructor are satisfied that you can ride safely.

## Session Information

<b>Who.</b>	Entire group
<b>What.</b>	Introduce the course, set expectations, and get participants comfortable
<b>Where.</b>	Classroom
<b>Method.</b>	Icebreaker and interactive lecture

## Timing

Program goals, agenda, etiquette and rider responsibility	10 min
Group Introductions, Summary and Transition	5 min
<b>Total Time</b>	<b>15 min</b>

## Introduction

A strong entry is imperative – Ride in on the Segway HT. Know how you will introduce yourself and the course before you begin speaking.

**Say:** Welcome to Basic Rider Optimization Training!

- > Introduce yourself.
- > Provide background facts that prove your credibility.
- > Paraphrase the introduction to Segway from the paragraphs below.

Provide/explain the following information:

- > Restrooms, coffee, phones, breaks
- > Request that cell phones be turned off
- > Beginning/ending times- confirm all will be present
- > Request that they sign the sign-in form
- > They should have their own helmets
- > Have them put their names in their Participant Workbooks

---

**Suggestion:** Create a flip chart page with the title: “It’s OK To...ask questions, get to know your classmates, have fun, drive carefully and responsibly, use the restroom, etc.”

---

Segway LLC is a Manchester, NH based business founded by renowned inventor and entrepreneur Dean Kamen to provide a solution to short-distance travel. The company has created the Segway™ Human Transporter (HT), the first self-balancing, electric-powered transporter designed to enhance the productivity of people by increasing the distance they can travel and the amount they can carry.

Kamen’s first big breakthroughs were in the medical field; he was still in college when his brother who is a physician complained that there was no way to easily dispense intravenous drugs to outpatients. The result was Kamen’s portable insulin pump. Dean’s list of inventions also includes a heart stent that keeps blood vessels open (Dick Cheney is a satisfied customer), and a shoebox-size dialysis machine that liberates kidney patients from constant hospital visits. Then came the IBOT™, a sophisticated mobility aid for the physically challenged designed to climb stairs and traverse uneven terrain. The IBOT’s amazing ability to move—and stand still—on two wheels while maintaining balance led Kamen to create a “human transporter” (please don’t call it a scooter). (*Newsweek, May 27, 2002*)

The Segway HT is a device that will extend and enhance your capabilities. Like all devices that give you freedom and independence, use of the Segway HT will be optimized if you have a thorough understanding of the Segway HT, its capabilities, and limitations. This training course is designed to give you insight into how the Segway HT operates, what it can and cannot do.

The Segway HT operates with the same principles of operation that humans use to walk. It can go about as fast as a person can run. It can stop and start quickly on dry pavement. It can go up and down slopes.

## Agenda

The Segway Basic Rider Optimization Training is a four-hour program providing Segway Human Transporter (HT) riders with an introduction to basic riding techniques, safety features-- how to recognize and respond appropriately, overview of service procedures, and spotting techniques used in guiding other riders.

1. 15 min/Review program goals and agenda  
Company overview, company philosophy- safety, etiquette, rider responsibility
2. 20 min/Show Safety Video
3. 15 min/Segway HT parts and facts  
Theory of operation
4. 30 min/Demonstrate operational model to all participants. (i and e Series together)  
Guided ride/first ride for each participant. Correct posture, foot placement, stopping, moving forward, reverse, and turning in place. Forward stop exercise – short distances, slow and long distance, more speed, speed limiter and backward stick shake. Wide turns versus turning in place. Maintaining lateral stability
5. 30 min/*i and p Series only: 15 min. instruction/15 min. break*  
*e Series only or combination of models for all riders: 30 min.*  
\*More time required for stepping on, stepping off, and weight distribution with e Series  
**All** step off, shut down.  
**Split** i and p Series riders in one group, and e Series riders in another (2 instructors).  
Use of Key, Mode Button, stepping on, stepping off, and shutting down, Power Assist Mode, Balance Mode, turn in place with new Key, cones, controlled stops.
6. 20 min/Conduct Skills and Drills on flat and uneven terrain. Emphasize grace and control  
Cones, funnel, stops, rumble strip, ramps/curbs, Power Assist Mode  
Coach riders on proper techniques and behavior, and rider responsibility
7. 10 min/Safety Q&A and demonstrations as requested.
8. 20 min/Show/explain basic service procedures: check tire pressure, fill tires, remove Battery Packs, straighten Control Shaft. Explain the hex wrenches.  
Display Icon explanation
9. 30 min/Ride Outside or discuss riding techniques over various surface conditions
10. 30 min/Demonstration and Guided Ride, spotting techniques
11. 20 min/Review, General Q&A, Hand out “Review” packet. Discuss Segway Etiquette and Safety reminders. Riders complete Safety Quiz and Accountability checklist, and hand in to Instructor. (Instructor must collect these, and forward to Training Coordinator in Manchester.)

At the end of this course, you should be able to:

- > Optimize your usage of the Segway HT in a controlled and responsible fashion. (Ride within **your** capabilities. Ride within **the Segway HT's** capabilities.)
- > Recognize and adapt your riding technique to environments for which the Segway HT has been designed. (Anticipate and adapt to your **environment**.)
- > Recognize and respond to warnings and alerts from the Segway HT.
- > Perform basic maintenance and service procedures.

## Group Introductions

Take a moment to introduce yourself to the rest of the class.

**Optional ice-breaker/confidence builder:** Ask, “What do you do really well?”

The instructor should begin forming an idea of what the participant’s learning preferences are as early as possible. Your participants will be some combination of preferences, but perhaps they respond better or more quickly to one type of information (Auditory, Visual, Tactile, Interactive). Try to discover if they prefer to watch, listen, read, ask, or do. Figure out if they are the type that wants to go first, or watch others before trying something themselves.

Please tell us:

- > What is your name?
- > How will you use the Segway HT?
- > What experience have you had to date with the Segway HT?
- > What specific information do you want to take away with you from this course?

**Optional Exercise— Explain phases of learning:**

Unconscious Incompetence	>	Conscious Incompetence	>	Conscious Competence	>	Unconscious Competence
<b>You don't know what you don't know.</b>		<b>You DO know what you don't know.</b>		<b>You DO know what you DO know.</b>		<b>You don't know what you do know.</b>

1. **Unconscious Incompetence:** When something new is introduced, for example a magic wand, and someone asks you if you know how to use it, you might say... “uh, I don’t know, I guess so” and accidentally turn your instructor into a frog!
2. **Conscious Incompetence:** Continue the same analogy. You might be scared to pick up the wand again, because you do know that you have no idea how to use it.
3. **Conscious Competence:** After you take a wand-training course, you learn the capabilities of the wand, and how to turn your instructor into a frog or a billionaire. You have depth of knowledge, and know how to use it in a **repeatable** way.
4. **Unconscious Competence:** You become fluent in your abilities. As easily as you breathe or speak your native language, you wave your magic wand to create whatever you like without thinking about the process.

## Summary

In this overview, you learned what you will experience during this class. You will finish this course having been given the opportunity to gain an understanding of your own capabilities, and those of the Segway HT. Next, we’ll talk about the Segway HT and how it works.

## > Session 2 Specifications, Components, Theory of Operation

<b>Who.</b>	Entire group
<b>What.</b>	Segway HT specifications (i, e and p Series), components show and tell, dynamic stabilization, and lateral stability.
<b>Where.</b>	Classroom
<b>Method.</b>	<b>Visual:</b> show components, <b>audio:</b> explain, <b>tactile:</b> hand out components for each participant to touch.

### Timing

Introduction, Objectives, Specifications	5 min
Components	5 min
Theory of Operation, Summary and Q&A	5 min
<b>Total Time</b>	<b>15 min</b>

---

**Note:** Arrange all components on table for participants to see. If you have a chassis, lay in the Controller Board and BSA.

---

### Introduction

In this session, you will learn the specifications for each Segway model. You will be shown the main components of the Segway HT, and then we will discuss how the Segway HT balances.

### Objectives

**Upon completion of this session the rider should be able to:**

- > State the speed, distance, and weight capabilities of the Segway HT
- > Identify the location of Segway HT components
- > Discuss how the Segway HT balances forward, backward and laterally

### Topics

**The following topics will be covered in this session:**

- > Specifications
- > Components of the Segway HT
- > Theory of Operation
- > Summary

## Specifications

Following are specifications for the i, p and e Series Segway HTs. The i Series is optimized for travels on or off the beaten path—on gravel, grass, bumpy trails or gentle slopes. It can travel longer distances and has greater stability than the p Series. The p Series is smaller, narrower, and lighter. It is designed to operate in dense, urban environments as well as indoors. The e Series is designed for commercial applications. Based on the i Series, it has many of the same features, with the addition of an electronic Parking Stand that allows it to park in place without powering down.

Segway HT Model	i167 and e167	p133
<b>Battery Pack Type</b>	NiMH	NiMH
<b>Range on a Full Charge <sup>1</sup></b> Make sure to review the variables that affect range, listed in the Table Footnotes at the end of this table.		
<b>Optimum range:</b>	12 miles (19 km)	10 miles (16 km)
<b>Typical range (good conditions):</b>	10 miles (16 km)	8 miles (13 km)
<b>Typical range (varying terrain and speed):</b>	8 miles (13 km)	6 miles (10 km)
<b>Weight Limits for Riders and Cargo <sup>2</sup></b> Make sure to review the weight limit information described in the Table Footnotes at the end of this table.		
<b>Maximum payload (rider plus all cargo):</b>	260 lbs (118 kg)	210 lbs (96 kg)
<b>Minimum rider weight:</b>	100 lbs (45 kg)	100 lbs (45 kg)
<b>Maximum weight of Handlebar cargo and attachments:</b>	10 lbs (4.5 kg)	10 lbs (4.5 kg)
<b>Maximum weight of Segway-approved side cargo bag (each):</b>	30 lbs (13.6 kg)	30 lbs (13.6 kg)
<b>Dimensions</b>		
<b>Platform height:</b>	8.3 in (21 cm)	6.7 in (17 cm)
<b>Footprint:</b>	19 x 25 in (48 x 64 cm)	16 x 21.8 in (41 x 55 cm)
<b>Overall height:</b>	37 to 50 in (94 to 127 cm)	35.5 to 46.5 in (90 to 123 cm)
<b>Weight</b>	i Series: 83 lbs (38 kg) e Series: 95 lbs (43 kg)	70 lbs (32 kg)
<b>Operating, Charging and Storage Conditions</b> If you use, charge or store your Segway HT outside these conditions, you may experience reduced range, ineffective Battery Pack charging, and damage to your Segway HT.		
<b>Operating conditions:</b>	Temperature: 32°F to 122°F (0°C to 50°C) Humidity: 5% to 95% RH Altitude: Sea Level to 12,000 ft (3,658 m)	Temperature: 40°F to 122°F (4°C to 50°C) Humidity: 5% to 95% RH Altitude: Sea Level to 12,000 ft (3,658 m)
<b>Optimum charging conditions:</b>	Temperature: 41°F to 68°F (5°C to 20°C) Humidity: 5% to 95% RH Altitude: Sea Level to 12,000 ft (3,658 m)	Temperature: 41°F to 68°F (5°C to 20°C) Humidity: 5% to 95% RH Altitude: Sea Level to 12,000 ft (3,658 m)

Segway HT Model	i167 and e167	p133
<b>Storage and transport conditions (less than one month only):</b>	Temperature: -4°F to 122°F (-20°C to 50°C) Humidity: 5% to 95% RH Altitude: Sea Level to 40,000 ft (12,192 m)	Temperature: -4°F to 122°F (-20°C to 50°C) Humidity: 5% to 95% RH Altitude: Sea Level to 40,000 ft (12,192 m)
<b>Turning Radius</b> One characteristic of a pedestrian is the ability to turn in place without impacting any nearby person or object.	Zero. The wheels can rotate in opposite directions, enabling the Segway HT to turn in place By balancing on a single axle, the Segway HT rider acts no differently than a pedestrian, and can ride in an elevator or narrow pathways- just as a person can walk.	Zero. The wheels can rotate in opposite directions, enabling the Segway HT to turn in place The wheels can rotate in opposite directions enabling the Segway HT to turn in place.
<b>Top Key Speeds<sup>3</sup></b> Steering grip sensitivity is proportional to the Key. The Open Environment Key provides the fastest turning rate, the Sidewalk Key is about 67% as fast, and the Beginner Key is about 50% as fast.	Beginner Key- 6 mph (9.6 km/h) Sidewalk Key- 8 mph (14.4 km/h) Open Environment Key- 12.5 mph (20 km/h) A rider can travel a mile in less than 5 minutes at top speed, but this will deplete the Battery Level much more quickly than traveling below the top speed of each key.	Beginner Key- 6 mph (9.6 km/h) Sidewalk Key- 8 mph (14.4 km/h) Open Environment Key- 10 mph (16 km/h)

## Table Footnotes:

### 1. Range on a Battery Pack charge is affected by many variables, including:

- > Temperature — storing, charging and riding within the recommended temperature parameters will improve range.
- > Rider Weight and Cargo — lighter riders with less cargo will typically get better range than heavier riders with more cargo.
- > Tire Pressure — riding with tire pressure below the specified limit reduces range.
- > Terrain — smooth and flat terrain optimizes range; riding on hilly terrain and unpaved surfaces decreases range.
- > Speed — consistent, moderate speed increases range; frequent acceleration and deceleration decreases range.
- > Battery Pack Condition — properly charged and maintained Battery Packs provide greater range; old, cold, heavily used, or poorly maintained Battery Packs provide less range.
- > Wind — tailwind increases range; headwind reduces range.

Only experienced riders riding in optimum conditions will reach the optimum range distances stated above.

### 2. Weight Limits for Riders and Cargo

Segway sets weight limits primarily for rider safety, as well as to reduce risk of damage to the Segway HT.

#### Dynamic Weight Limits

To keep the Segway HT and rider upright, the Segway HT must always have enough power to be able to turn its wheels forward and backward. Exceeding the weight limits, especially when combined with other variables that require more power (see list below), will increase your risk of falling or damaging the Segway HT.

#### Variables that require more power include:

- > Higher payloads (weight of rider and all cargo)
- > Steeper slopes
- > Bumpier surface conditions
- > Higher speeds
- > Abrupt maneuvers

Since the Segway HT can monitor the amount of power being used, the Segway HT will limit the speed (and potentially perform the Stick Shake Warning) in response to these variables. It is important that all riders learn to anticipate and recognize when the Segway HT is reaching the limits of performance.

**Minimum Weight Limit**

The rider's weight must not be less than 100 lbs. (45 kg). If the rider is below the minimum rider weight limit, she may not be able to ride safely because she cannot shift her weight far enough back (behind the centerline of the wheels) to safely slow down and stop, especially when riding downhill. Also, riders below the minimum weight limit might fail to properly activate the Segway HT's balancing system.

**Structural Weight Limits**

Increased risk of damage to the Segway HT is another consequence of exceeding the maximum weight limits. Heavier payloads place greater stresses on the Segway HT. Segway's testing has shown that the stresses created by a payload within the total payload weight limit (with any cargo not exceeding the applicable cargo weight limits), ridden on a wide variety of terrain in accordance with the instructions in this Workbook will not damage the Segway HT. Just like the dynamic weight limits, several factors affect the loads transmitted to the Segway HT:

- > Skill level of the rider
- > Payload (weight of the rider and all cargo)
- > Surface condition (obstacle height, etc.)

The stresses created by exceeding the rider or cargo weight limits, especially when riding on uneven terrain, could damage the Segway HT.

**Handlebar Cargo**

The total weight of any Handlebar payload plus any other attachments hanging from the Handlebar should not exceed 10 lbs (4.5 kg). Exceeding this limit interferes with the Segway HT's balancing ability and could cause the Segway HT to accelerate on its own, risking injury and damage.

**Side-bag Cargo**

The total weight of each Segway-approved side cargo bag should not exceed 30 lbs (13.6 kg). Exceeding this limit interferes with the Segway HT's balancing ability, and could cause the Segway HT to tip over sideways, or increase the difficulty of stopping, especially when riding downhill.

**3. Top Key Speed**

Top Key speed refers both to forward speed limits, and turning rate.

The ease of controlling your speed based on the riding environment is the relevant metric. The intuitive control of a Segway HT means that in crowded pedestrian environments, the Segway HT can easily go the speed of those around you, from zero speed to the top Key speed on any Key.

The intuitive self-balancing control and stopping ability allow a Segway HT to easily travel at the speed that is comfortable in any environment. Unlike a bicycle or scooter, there is no minimum speed required to maintain balance, nor is there a throttle which makes velocity difficult to control at lower speeds.

Turning sensitivity changes depending on the key used. The most responsive turning rate is achieved with the Open Environment Key. It is very important to ride and turn with control, especially as you increase your top forward speed.

## Components of the Segway HT



01. Steering Grip
02. Fixed Steering Grip
03. Key Port
04. Display Bezel
05. Handlebar
06. Fixed Grip
07. Handlebar Trim
08. Display
09. Key
10. Mode Button
11. Height Adjustment Collar
12. Control Shaft
13. Mat
14. Control Shaft Cord
15. Front Trim
16. Control Shaft Clamp Wedge (1 of 2)
17. Cover
18. Controller Boards
19. Balance Sensor Assembly
20. Parking Stand
21. Battery Packs
22. Motor
23. Gearbox
24. Fender
25. Tire/Wheel Assembly
26. Wheel Nut
27. Charging Indicators
28. Charge Port, Charge Port Cover
29. Control Shaft Clamp Wedge (2 of 2)
30. Control Shaft Base

## Mode Button, Display and Key Port

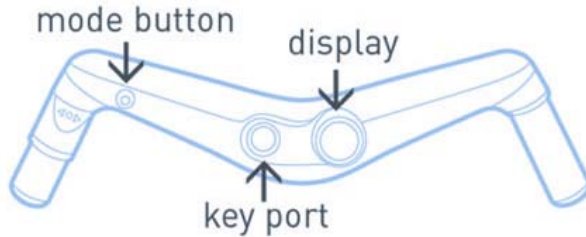

### Notes:

The **Mode Button** is used to transition between Power Assist Mode and Balance Mode, (tap) and to turn off the Segway HT (hold down until you see a sleepy face – approximately 2 seconds.)

The **Display** is designed to provide information in easy-to understand images for all languages. Provides information about battery charge level, operational mode, and alerts.

The **Key Port** has 3 points of contact. Make contact with the middle point and *either* outside point. Don't push down or you will

## Steering Grip

Turn the grip to go left or right, in Balance Mode, or back and forth in Power Assist Mode.

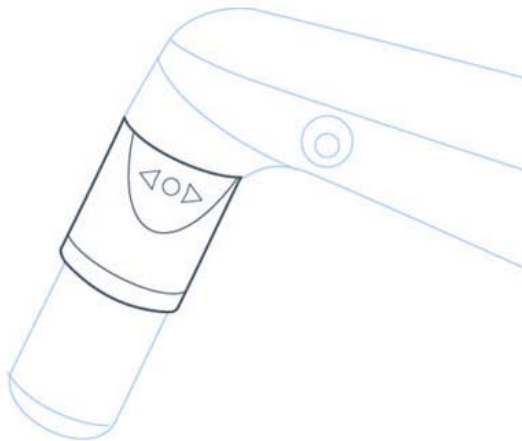

### Notes:

The **Steering Grip** responds in proportion to the amount it is twisted. The more you twist, the faster you will turn while in Balance Mode. For each key, the Steering Gripsensitivity is calibrated to affect the same turning radius at top speed. When in Power Assist Mode, the speed at which the Segway HT moves forward and backward when you twist the Steering Grip does not change with the different Keys.

(Imagine a marching band in a row. As the row begins to turn, the outside marcher increases his pace, while the innermost marcher reduces her pace. They all accomplish the same turning radius.)

## Key

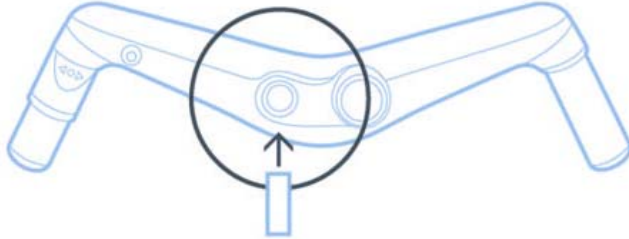

### Notes:

There are three types of **Keys**- each has a different top speed when riding forward:

- > Beginner Key (6mph /10 km/h)
- > Sidewalk Key (8 mph / 13 km/h)
- > Open Environment Key (12.5 mph / 19 km/h) for the i and e Series Models, and 10 mph / 13 km/h for the p Series Model.

There is a 64-bit ID-encoded number on each key for security. This is similar to a password, and can be directly read from the key. There are 18,000,000,000,000,000 (not a typo!) unique combinations.

## Control Shaft, Height Adjustment Collar and Control Shaft Base

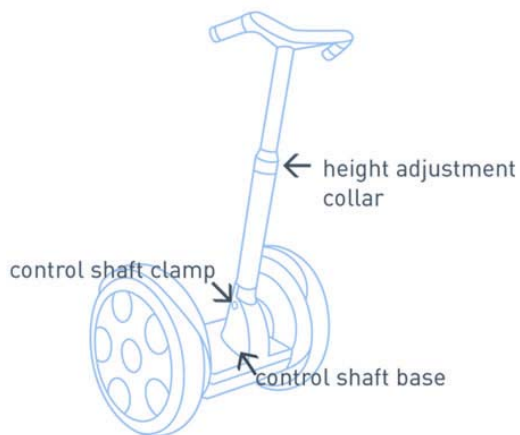

### Notes:

Adjust the height with the **Height Adjustment Collar**. **DO NOT** over-tighten the Height Adjustment Collar. Just make it snug.

The Height Adjustment Collar does not “fix” a Handlebar/Control Shaft Assembly that twists. If the Handlebar/Control Shaft Assembly is twisting right and left, loosen the **Control Shaft Clamp** bolt, lay the Handlebar against the floor to straighten, make sure the Control Shaft is fully inserted into the top of the **Control Shaft Base** to protect from water damage, then tighten the bolt holding the clamp with the Hex wrench provided.

The **Control Shaft Base** houses a charge port capable of handling input voltage range between 100v and 240v, 50-60Hz and current draw on input is 1.4 amps. Use an adapter for different countries' plug configurations.

## Platform and Rider Detect Sensors

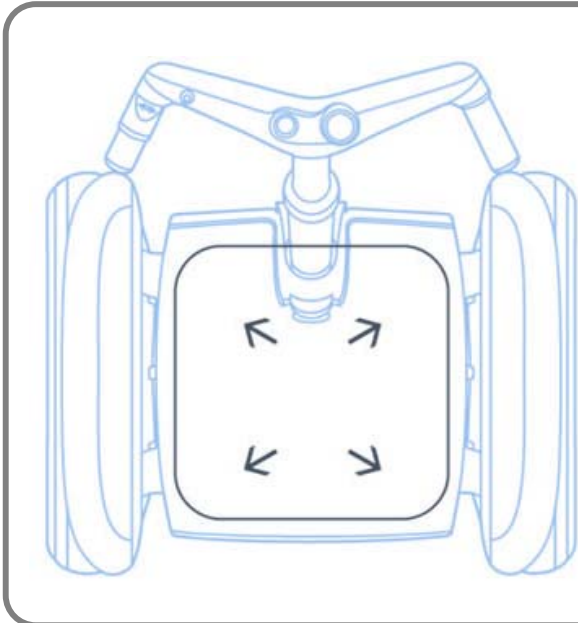

### Notes:

Four rubber diaphragms (**Rider Detect Sensors**) are injection-molded into the **Platform**. When you step on the Platform, rubber diaphragms deflect down into the control electronics below and the self-balancing systems engage. This creates a wireless rider detection system and gives the sensors equal ability to detect the absence and presence of a user.

The Segway HT needs to see three or more sensors deflected to operate in Balance Mode with full functionality. If you depress only one or two sensors, the Segway HT will perform in reduced functionality by limiting forward speed.

## Motors

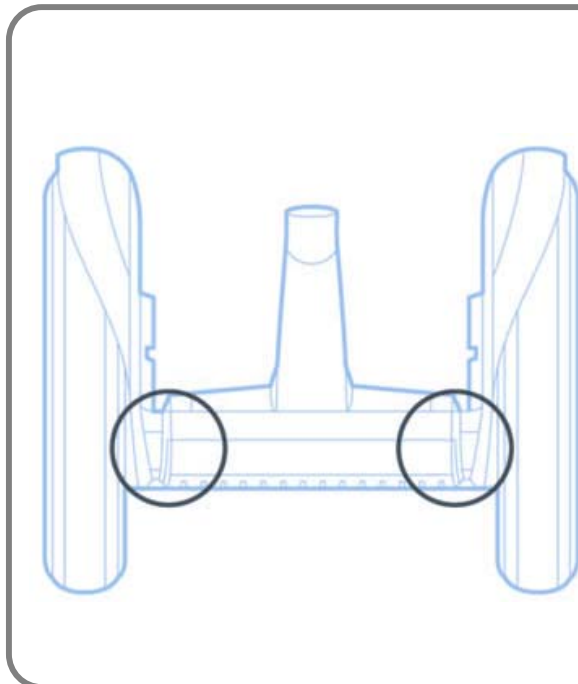

### Notes:

Each wheel is independently driven by redundant, high-speed electric **Motors** that produce no emissions. Our brushless DC motors are maintenance-free, and employ computer technology to precisely regulate motion.

The motors have been tested to power levels of two horsepower.

Redundancy: Each motor is wound as two separate electrical circuits, capable of independent operation, acting as one mechanical entity. (Show the two connection points on the motor if you have a sample.)

If one part of a motor fails, the other part continues to operate long enough to bring you safely to a stop. The Segway HT will perform a Safety Shutdown. You have approximately 10 seconds before the Segway HT powers off.

## Gearboxes

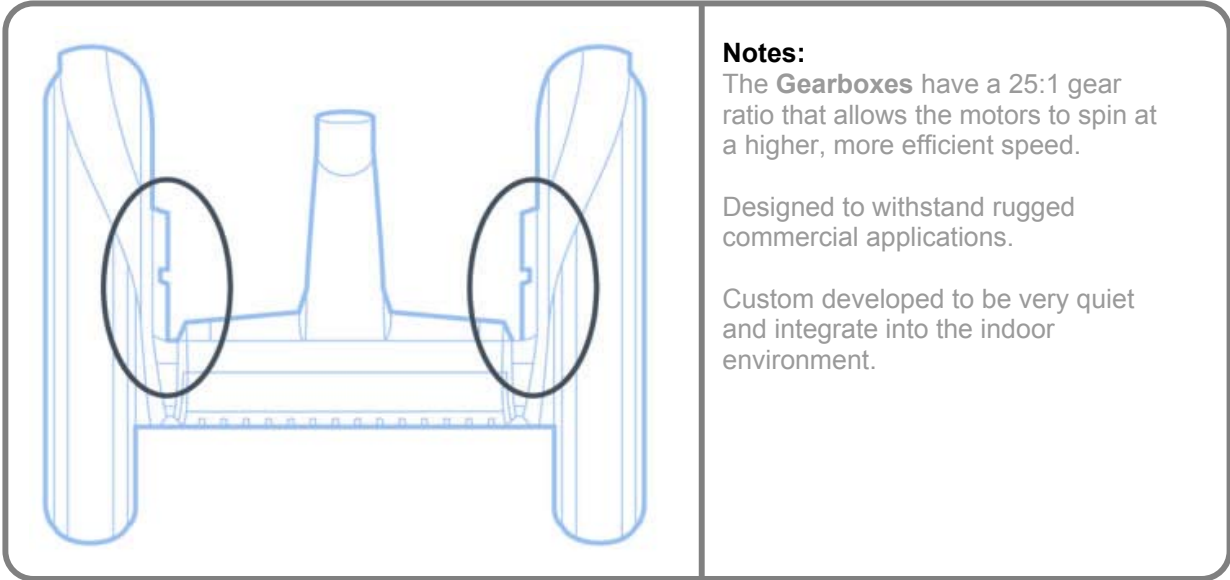

### Notes:

The **Gearboxes** have a 25:1 gear ratio that allows the motors to spin at a higher, more efficient speed.

Designed to withstand rugged commercial applications.

Custom developed to be very quiet and integrate into the indoor environment.

## Battery Packs, Charge Port and Charging Indicators

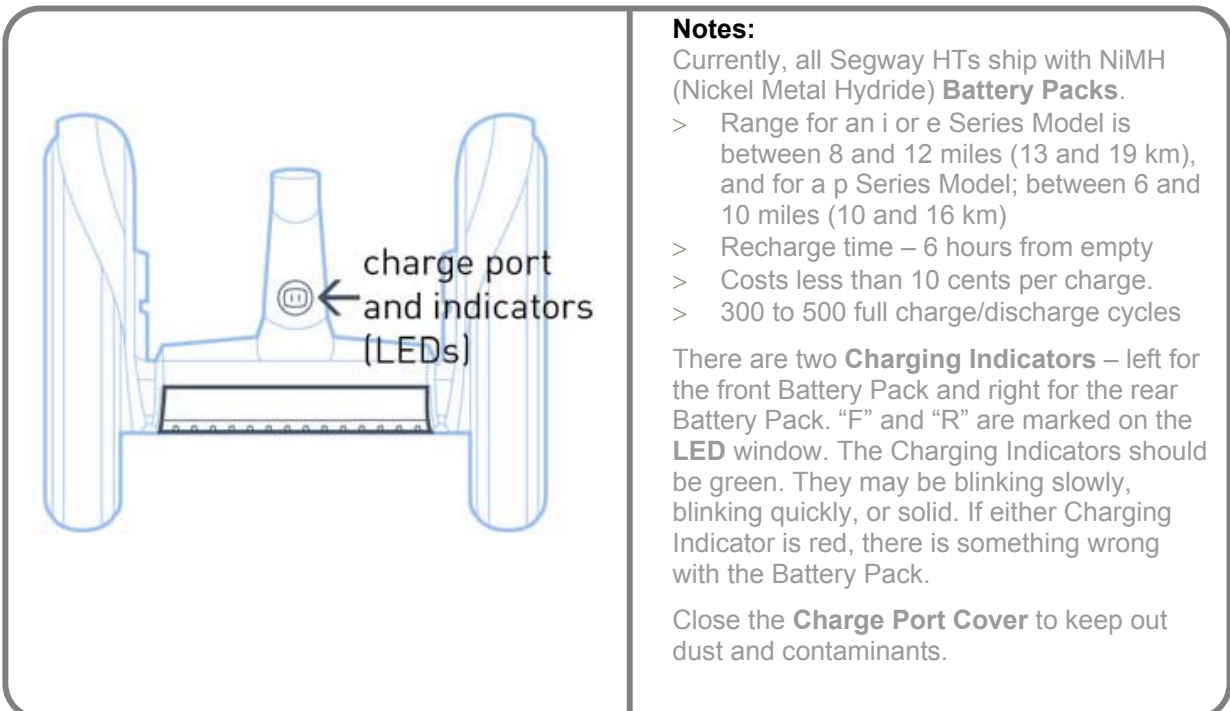

### Notes:

Currently, all Segway HTs ship with NiMH (Nickel Metal Hydride) **Battery Packs**.

- > Range for an i or e Series Model is between 8 and 12 miles (13 and 19 km), and for a p Series Model; between 6 and 10 miles (10 and 16 km)
- > Recharge time – 6 hours from empty
- > Costs less than 10 cents per charge.
- > 300 to 500 full charge/discharge cycles

There are two **Charging Indicators** – left for the front Battery Pack and right for the rear Battery Pack. “F” and “R” are marked on the **LED** window. The Charging Indicators should be green. They may be blinking slowly, blinking quickly, or solid. If either Charging Indicator is red, there is something wrong with the Battery Pack.

Close the **Charge Port Cover** to keep out dust and contaminants.

## Controller Boards

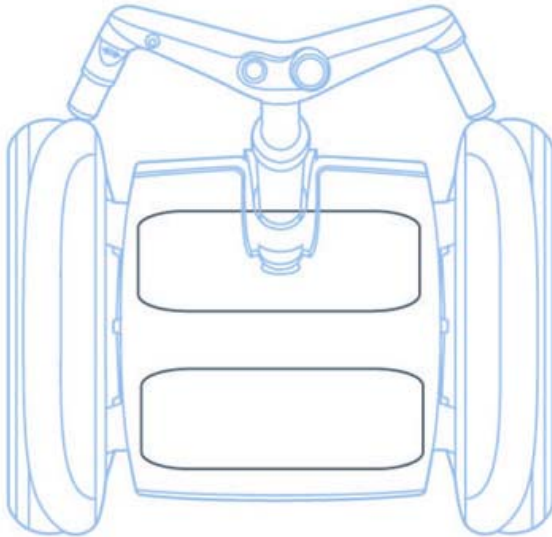

### Notes:

The **Controller Boards** receive input from the gyroscopes and other sensors to evaluate performance and operating conditions. They also monitor battery condition during operation.

The Controller Boards send commands to the Motors based on information received from the steering control, gyroscopes and other sensors.

**Redundancy:** The two Controller Boards work in concert and are interchangeable (but not user-serviceable). Each has the ability to assume full responsibility for operation should there be a malfunction in its counterpart. In the case of a Controller Board failure, the Segway HT will continue operation for approximately 10 seconds while it performs a Safety Shutdown.

## Balance Sensor Assembly

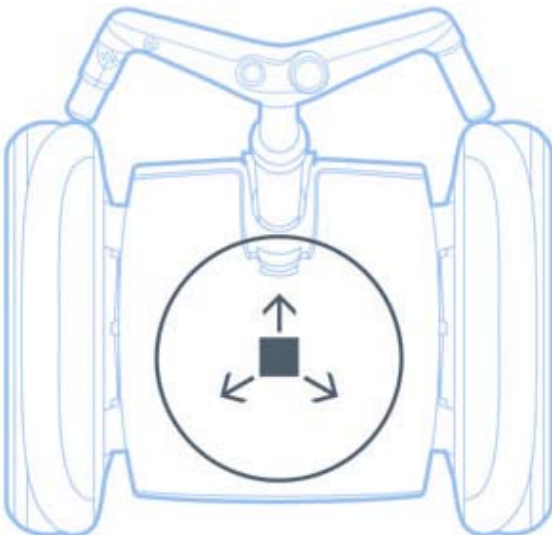

### Notes:

The Balance Sensor Assembly (BSA) is composed of gyroscopes and tilt sensors. The BSA determines the orientation of the Segway HT relative to the direction of gravity. The BSA communicates with the Controller Boards to keep you balanced.

The tilt sensors check each other continuously. If you perform activities which result in jostling of the tilt sensors to a point at which the Segway HT is unable to assess whether or not it is balancing correctly, the Segway HT will activate the speed limiter and display the icon indicating reduced performance. The Segway HT will return to normal operation when the transient inputs have been diminished.

**Redundancy:** There are five gyroscopes (angular rate sensors), each oriented in such a way that any angular motion (pitch/roll/yaw) of the Segway HT will be sensed by at least two gyroscopes.

## Fenders

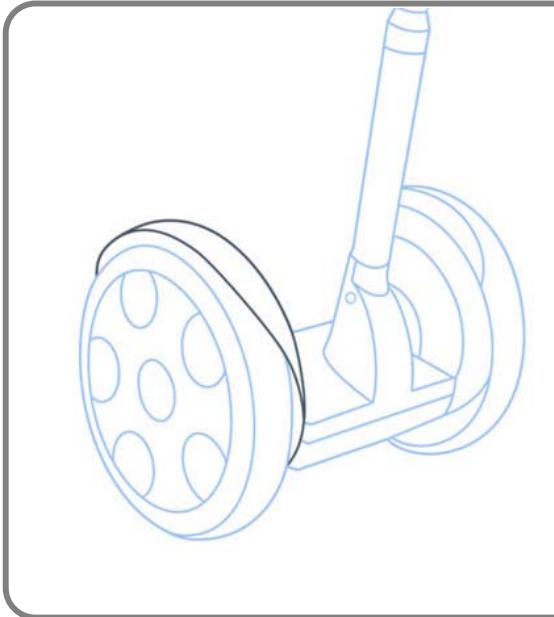

### Notes:

The **Fenders** are manufactured from an unpainted resin that is scratch resistant. They cover the wheels to protect clothing and reduce splatter in wet conditions.

To protect fenders, always stand in front (Handlebar side, not Platform side) of the Segway HT when using Power Assist Mode to negotiate curbs/stairs. This provides greater clearance.

When changing wheels, or lifting the Segway HT, keep your hands clear of the space between wheels and fenders.

## Parking Stand (i Series only)

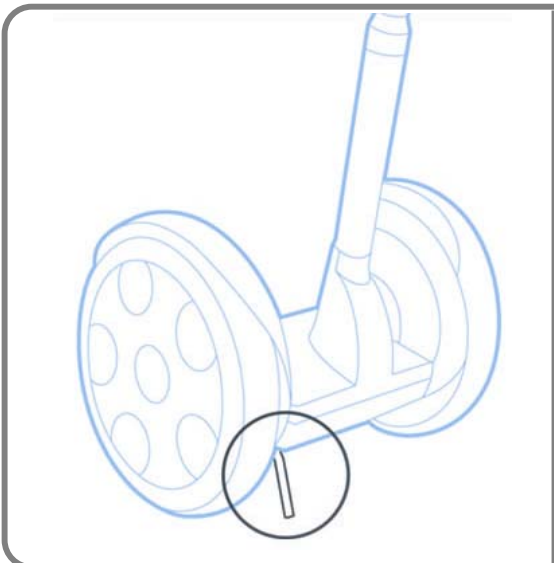

### Notes:

There is no **Parking Stand** on the e or p Series Segway HTs – only on the i Series model.

Remember: Using the Parking Stand should be the **FIRST** and **LAST** activity in the operational model. The Parking Stand is not designed to bear a rider's weight. Standing on the Segway HT with the Parking Stand deployed will likely result in breaking the Parking Stand. If the Parking Stand is deployed while riding the Segway HT, it is designed to break rather than endanger the rider by obstructing movement.

Replacement requires removing the Tire/Wheel Assembly, the Fender, and the Mat.

## Tires and Wheels

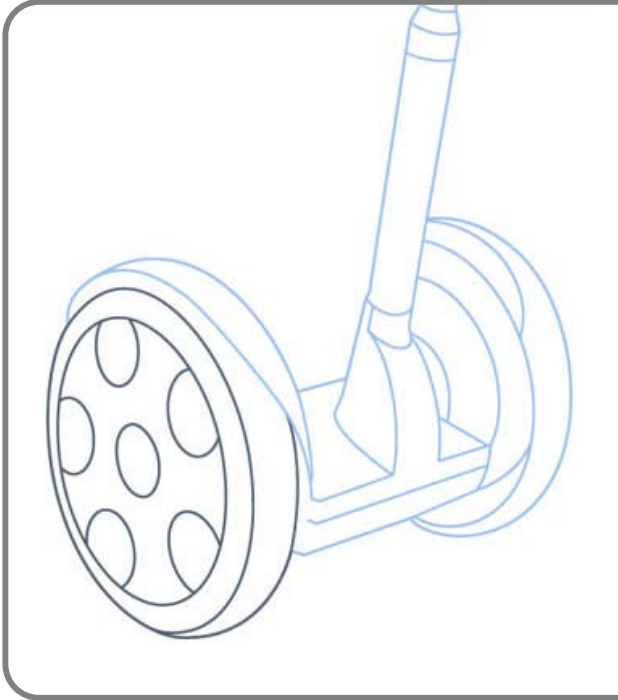

### Notes:

The tires are produced by Michelin and are designed to maximize range with low rolling resistance. The low-pressure tires provide a comfortable ride. They are manufactured using a non-marking, silica-based compound for use on floors and rugs with no damage. The tires are tubeless

Recommended pressure is as follows:  
i and e Series: 15 psi (103 kPa) to 22 psi (152 kPa), depending on payload weight. Increase the psi (kPa) as you increase payload weight.

p Series: 22 psi (152 kPa).

Tire and wheel assembly comes together. This is a user-replaceable part

## Component Review

Ask some/all of the questions below to ensure retention/comprehension of the content. Feel free to throw in some of your own questions.

1. How do you turn off the Segway HT?
2. How do you change from Balance Mode to Power Assist Modes?
3. Explain how the Steering Grip works.
4. Describe the different Keys.
5. How do you adjust the height of the Handlebar/Control Shaft Assembly? Would I do the same thing if my Handlebar were twisted?
6. How many Rider Detect Sensors are there? How many are needed for normal operation?
7. How many motors are there? What does "dual redundant" mean?
8. What happens if one of the motor components malfunctions?
9. List conditions which affect charge/range.
10. How can you tell your Battery Packs are charging?
11. Can you put the front Battery Pack in the rear and vice versa?
12. How many Controller Boards are there?
13. If one Controller Board has a malfunction, what happens?
14. How do the Controller Boards, balance sensor assembly and motors interact?
15. How many gyros? How many tilt sensors? Why so many? What happens in the event of a malfunction?
16. Tires are low pressure or high pressure?

## Theory of Operation

The Segway HT uses a technology called dynamic stabilization. When you lean forward, the Segway HT moves forward. When you lean backward, the Segway HT moves backward. The sensations of movement are similar to those that people experience everyday while walking.

Ask participants to stand, and move away from the table. Explain that, while stationary, their center of gravity is over their contact patches (feet). Describe contact patch as the part of you or the Segway HT that is in *contact* with the ground. Show how a larger contact patch is more stable than a smaller one by standing on your toes. An analogy you can use to describe a large contact patch and a small one is to compare the surface of your entire foot against the ground versus just standing on your toes.

Explain that humans dynamically stabilize by moving their contact patch beneath their center of gravity. Ask everyone to take a step forward and notice their feet dynamically change position to keep them balanced. Compare the Segway HT's wheel movement to a person's feet, when you change the center of gravity.

Ask the participants to stand on one foot only and balance. Ask if they can feel their grounded foot correcting to keep them balanced. Explain that it is this type of input that the Controller Boards and BSA receives and uses to maintain balance- just as a person's brain takes the input when standing on the ground.

---

**Note:** The instructor should observe the participants to see if anyone has trouble balancing on one foot, and if so, how much trouble. Trouble balancing could be an indication that the participant will have difficulty controlling his/her center of gravity on the Segway HT, and may need extra attention.

---

Ask participants to take their seats.

## Dynamic Stabilization

Many objects balance statically. A coffee table remains balanced by maintaining a wide stable base, and keeping a low center of gravity. If you lengthened the legs, you would raise the center of gravity and increase its "tippiness." Or, if you removed one of four legs, you would destabilize the table, and it would no longer balance.



Humans are unique because they balance dynamically. In order for a human to stay balanced while moving, she has to keep her center of gravity, which is high over her base (contact patch), which is narrow.

The **contact patch** on the Segway HT is the part of the wheel that is in contact with the riding surface (i.e., ground, rug, pavement, slope).



The Segway HT has no throttle or brake controls, and responds to your every move as if it were an extension of your body. As you lean forward, the Segway HT detects this and drives the wheels as needed to keep you upright while moving forward.



Stand up straight (center of gravity over the contact patch), and the Segway HT slows to a stop. Once stopped, leaning back also allows you to move backwards.



The Segway HT can balance in place, allowing you to stand motionless by detecting minute changes in balance and instantly responding. There is no need to step off the Segway HT when stopped.



When commanded, the Segway HT can rotate one wheel forward and one backward, turning in place.



The basic notion of dynamic stabilization is that the wheels produce torque when the Platform is **not** level. If the Platform is tipped forward, the wheels drive forward. If it is tipped back, the wheels drive back. During normal operation, this has the effect of keeping the Platform level. The tilting of the Platform is transient – on average, the Platform stays level.

The rider uses the transient tilting to accelerate and decelerate. The rider causes acceleration by placing the center of gravity of the system (rider + Segway HT) forward or aft of the contact patch.

The operator causes deceleration by moving the center of gravity opposite to the previous position with relation to the contact patch. (For example, move the center of gravity behind the contact patch, if it was forward, or vice versa.)

When moving forward, I reorient my center of gravity *aft* of the contact patch to decelerate. When moving backward, I reorient my center of gravity *forward* of the contact patch to decelerate. In both cases, if I do NOT transition my center of gravity directly *over* the contact patch at the point when I am almost stopped, I will simply begin to accelerate again in the new direction.

To *remain* stationary, *once stopped*, the center of gravity needs to be directly *over* the contact patch.

---

**Exercise:** Ask participants stand.

Say, “Your feet are contact patches—they are making contact with the ground. Now, move your and **dynamically stabilizing**. You got it— just like the Segway HT does when you are riding it!”

---

## Lateral (side-to-side) Stability

Above, we discussed **dynamic stabilization** as the technological principle that the Segway HT uses to balance forward and backward. In contrast, the Segway HT does not dynamically stabilize laterally.

---

**Ask:** “Does the Segway HT provide any lateral stability?” The answer is YES, but only statically. It doesn’t move side-to-side dynamically to maintain balance. The rider has to do that! (I usually push a chair over to illustrate how, statically, the chair was maintaining lateral stability just fine, but dynamically, it was not able to correct. Now, if I sat in the chair, and tilted it to the side, then used my legs and body to tilt it back on its base, I would be acting as a dynamic stabilizer- the same way I have to when I am on the Segway HT.)

---

Dynamic stabilization technology balances the Segway HT forward and backward. The **rider** must maintain **dynamic** lateral stability (side-to-side).



This rider is demonstrating correct body position. Note how the rider bends one knee more than the other to lean into the turn.



This rider is demonstrating incorrect body position. The rider is not leaning into the turn.



Correct body position



Incorrect body position. **Avoid any surface that can result in lateral instability.**

When riding over uneven terrain, you should maintain a body position that puts your center of gravity over the center of the Platform. Do this by “absorbing” the difference in height with relaxed, bent knees and arms.

## Summary

Over the course of this training, you will be learning how to use the Segway HT.

- > Do not perform any operation with the Segway HT until directed by your instructor.
- > Do not ride in any area without approval from your instructor.
- > If you are uncomfortable with any operation or maneuver, **STOP** and ask for assistance.

## Individual Learning Curves

Your classmates will all learn at different rates. The most important part of this training is for you to understand **YOUR** capabilities and limitations with the Segway HT. Your good judgment and proficient skills are what make the Segway HT productive and safe.

## **The Mantra: *Calm, Controlled, Courteous***

You control the safe operation of the Segway HT. Your judgment, and awareness of your surroundings are essential to a safe, enjoyable experience.

- > Scan the environment ahead of you and the surface you are negotiating. The faster you are moving, the farther ahead you must scan.
- > Maintain awareness of your surroundings.
- > Maintain good posture – keep your arms and legs relaxed and flexed.
- > Slow down for pedestrians – pass slowly and courteously.
- > Slow down for corners and cross paths.
- > Recognize and respond to the Segway HT safety alerts.

## **Demonstrate Segway Etiquette**

- > Respect pedestrians by yielding the right of way to them in all cases.
- > Avoid surprising pedestrians. When approaching from behind, announce yourself and slow down when passing.
- > When approaching a pedestrian from the front, slow down.
- > In heavy pedestrian traffic, slow down and proceed at the pace of sidewalk traffic. Pass only if there is ample space to do so safely.
- > Do not park your Segway HT in a way that blocks pedestrian traffic.
- > Do not perform tricks or stunts.
- > Cross a road at designated crosswalks or signaled intersections. Do not jaywalk/ride.
- > Never take passengers on your Segway HT. It is designed for one rider at a time.

---

**Ask:** “Who has a question?”

---

### **Optional:**

- > Review the concepts of contact patch and center of gravity
- > Review how the Segway HT balances
- > Ask someone to contrast dynamic and static, pitch versus roll.
- > Ask about Segway Etiquette, and why it is important.

## > Session 3 Demonstration, Guided Ride, Skills & Drills

- Who.** Entire group. Go over preliminary information in classroom. Then, drill riders on a variety of maneuvers to promote riding competence. Optional: If there are more than 6 participants, split into two groups. One group stays in the classroom to do Display ID, and the other group goes out for their first ride.
- What.** Segway HT Model Comparison, Display Icons, and Guided Ride
- Where.** Classroom and Riding Space
- Method.** Lecture, self-paced exercise in dyads, observation and experiential learning

### Timing

Introduction and Objectives	5 min
Segway HT Model Comparison	5 min
Demonstration and Guided Ride	15min
Drills	40 min
Display ID	20 min
Summary and Q&A	5 min
<b>Total Time</b>	<b>1 hour, 30 min</b>

### Introduction

In this session, riders will have their first experience on the Segway HT and learn to operate the Segway HT independently on flat ground. Additionally, they will be introduced to the sounds, icons and colors in the Display.

#### Explain the following information:

Review the entire operational model with the class using the white board, or a Segway HT, to show participants what to expect on their first ride.

- > You will find the Segway HTs plugged in (i Series only, Parking Stand may be deployed).
- > Unplug the Segway HT and retract the Parking Stand (i Series only).
- > Instructor will start each Segway HT with a Beginner key, and instruct the participant to put the Segway HT into Balance Mode by tapping the Mode Button.
- > Instructor will brace each Segway HT individually while each rider steps on.
- > After some riding exercises, the rider will step off, while the instructor braces the Segway HT.
- > Rider will turn off Segway HT, deploy Parking Stand (i Series only), and plug in.

Initially, the instructor will guide participants through each step. Over time, the instructor will transition to a coaching role in order to encourage participants to become independent Segway HT operators.

As instructor sees fit, send individual riders – those who you believe might be ready for some unstructured riding time - to ride in a defined or coned area. This will allow you to spend time with other riders who might need more one-on-one help during this session.

If there is no assistant and you send riders for unstructured riding time in a controlled environment, make sure they are in your sight and that they know they can **ALWAYS** call for help.

At the end of the session the group will discuss questions or difficulties they encountered as well as a summary of the session.

## Objectives

### Upon completion of the First Ride the rider should be able to:

- > Interpret the meaning of Display icons by referencing the training materials
- > Identify and explain Power Assist and Balance Modes
- > Step on and off the Segway HT with guidance
- > Perform straight line maneuvers: forward and reverse
- > Stop the Segway HT on command
- > Turn the Segway HT 360° in its own footprint, both right and left
- > Ride the Segway HT around an oval maintaining speed control and executing gentle turns

### Upon completion of the Skills & Drills the rider should be able to:

- > Retract Parking Stand properly (i Series only)
- > Turn Segway HT on and off
- > Step on and step off from the Segway HT without guidance
- > Change from Balance to Power Assist without guidance
- > Walk with Segway HT in Power Assist Mode.
- > Stop on command
- > Ride on flat ground without guidance
- > Turn smoothly on command and without hesitation as well as in response to terrain features
- > Lean while turning
- > Ride on flat ground
- > Interpret meanings of the Display icons

### In addition, riders on e Series models should be able to:

- > Move an e Series model in and out of E-Stand
- > Distribute weight correctly in bags on an e Series model
- > Understand Rider Detection and E-Stand behavior

## Topics

### The following topics will be covered in this session:

- > Segway HT Model Comparison
- > Demonstration and Guided Ride
- > Riding Form
- > Parking Stand Deployment and Retraction (i Series only)
- > Key Choice
- > Stepping On
- > Turning
- > Loading and Unloading Cargo (e Series only)
- > Drills
- > Display Messages
- > Summary

## Segway HT Model Comparison

When entering Balance Mode, you need to orient i and p Series models differently from the e Series.

- > i and p Series: Platform is level
- > e Series: Control Shaft is vertical (perpendicular to the ground)

Rider detection behaviors are different for the i and p Series models, than the e Series model.

- > i and p Series: From a stationary position in Balance Mode, with no rider on, moves approximately three feet, stick shakes, then transitions to Power Assist Mode.
- > e Series: In Balance Mode with no rider on, engages E-Stand. May move approximately three feet and stick shake.

The i and p Series models react differently from the e Series model in the following circumstances:

- > When released from a stationary position while in Balance Mode
- > When entering Balance Mode

**If the Segway HT is in Balance Mode with no rider on, and is released from a stationary position::**

<b>i and p Series</b>	The Segway HT will move approximately three feet, stick shake and transition to Power Assist Mode. <b>DON'T DO THIS!</b> The Segway HT will not stay stationary unless blocked.
<b>e Series</b>	The Segway HT will transition to E-Stand, and stay in place (E-Stand), as long as it is released correctly.

The Segway HT must be powered on to engage either Balance Mode or Power Assist Mode.

**To transition to Balance Mode::**

<b>i and p Series</b>	Make sure the Platform is level, and then tap the Mode Button.
<b>e Series</b>	Make sure the Control Shaft is vertical (perpendicular to the ground), and then tap the Mode Button.

## Demonstration and Guided Ride

After you watch the instructor demonstrate the Segway HT's functions and capabilities, you will ride the Segway HT.

---

**Important:** *Physically block the back of the Platform to restrict the rider's ability to step onto the Segway HT prematurely, and/or explain that riders are not to step on the Segway HT until expressly instructed.*

---

### Part I—Demonstration

The Instructor will perform or instruct the participant to perform the steps in the operational model.

1. After checking the Charging Indicators to ensure that the Segway HT has been charging, unplug the Segway HT.
2. Retract the Parking Stand (i Series only).
3. Turn the Segway HT on. Use Beginner Key for the first ride. No need to explain the different keys at this point.

4. Check battery charge level, and explain how the segments around the perimeter of the Display blink and disappear to indicate the level (a detailed explanation of the Battery Packs and charging will take place in the Segway HT Maintenance session).
5. Adjust Control Shaft height.
6. Show how, by tapping the Mode Button, the Segway HT transitions from Power Assist Mode to Balance Mode.
  - a. **i Series**—make sure Platform is level
  - b. **e Series**—make sure Control Shaft is vertical
7. Demonstrate the left/right motion induced by twisting the Steering Grip while in Balance Mode
8. Demonstrate the proper form when stepping on
  - a. **i Series**—Place both hands on the Grips. Make sure to not twist the Steering Grip. Step on with one foot. Listen for tone. Step on with other foot.
  - b. **e Series**— With the Segway HT in E-Stand,
    - > Explain Rider Detect Sensors and how depressing them causes the e Series to level the HT, to make stepping on easier for the rider.
    - > Gently guide HT toward you on a level plane from beneath the grips or, hold the Control Shaft and guide the Segway HT toward you until the Platform is level. Step on with one foot, listen for the tone and wait one second while the Platform levels beneath your foot, then step on with your other foot; **or**
    - > Activate the Rider Detect Sensors by gently placing one foot flat on the Platform, wait one second until Platform levels, then step on with other foot. Be careful to step in the center of the Platform. Do NOT step on the back or front of the Platform, because the Segway HT will respond by moving its wheels beneath the center of gravity.
9. Demonstrate moving forward, backward, turning and staying stationary.
10. Show leaning turns by riding once around an oval
11. Stop. Step off. Explain that each participant will now have a chance to ride.

## Part II—Guided Ride

The instructor should position him/herself in front of the Segway HT with a firm grip on the Handlebar or Control Shaft (or both). Invite the first rider to stand before the Platform. This will be a serial exercise—one rider at a time on one Segway HT.

---

**Important:** Reiterate that riders are not to step on the Segway HT until expressly instructed.

---

1. Adjust the Control Shaft height to a position between the rider's waist and hips. Arms and legs should be slightly bent.
2. Instruct rider to stand to beside the Segway HT with feet clear of the Platform, and hold the Handlebar, to feel the Segway HT in Balance Mode.
3. Instruct the rider to maintain a hold on the Handlebar, and tap the Mode Button to change from Balance Mode to Power Assist Mode. Then, tap the Mode Button again to change back to Balance Mode.
4. Ask the rider to describe the Display (a green smiling face and moving vertical line).
5. Ask the rider to check that the Segway HT is in Balance Mode by slowly moving the Handlebar forward and back, and making sure the wheels respond.

6. Instructor should brace the Handlebar/Control Shaft, and instruct rider to:
  - a. Hold grips with both hands (For the e Series model, the instructor may choose to level the Platform for the rider, so it is similar to getting on an i Series model)
  - b. Look ahead
  - c. Slowly step with one foot onto Platform, centering your foot on the Platform. Centering your foot is especially important on the e Series model, to limit the Platform movement when the Rider Detect Sensors are activated.
  - d. For e Series models, make sure the rider understands the Rider Detect Sensors, and expects the Segway HT to level the Platform when they are depressed.
7. Have rider step onto Platform with other foot. Maintain firm hold. It is common for the rider to oscillate. If this happens, do the following:
  - a. Keep holding firmly.
  - b. Ask him to try to relax and stand still, as you hold the Segway HT still.
  - c. Assess whether the Segway HT is pushing toward you or away:  
**Pushing toward** you indicates that the rider is leaning too far forward, or that the rider's feet are too far forward. Have her shift weight, feet, or both backward. **Pulling away** from you indicates the opposite.
  - d. Emphasize that the rider controls movement by shifting her weight.
  - e. Explain that oscillation is common because the brain is not used to having something else balance for you. If the rider oscillates, ask her to step down off the Segway HT once you have stabilized it. Ask her to step back on, but trust that the Segway HT will balance. The rider's confidence and stability may improve.
  - f. Encourage the rider to trust the Segway HT, and relax her hands, shoulders, arms and knees.
8. Check position of feet, and ensure that feet are placed in such a way that the rider can remain stationary. Ideal foot position depends on the rider's body type, not necessarily on foot position. In some cases, the rider's feet may be positioned further forward or back on the Mat in order to remain stationary.
9. Check rider posture – bent knees, relaxed shoulders. A rider may begin turning the Segway HT accidentally, as a result of a tight grasp on the Steering Grip. The instructor must hold the Segway HT firmly so it doesn't move forward or backward, and make the rider stop twisting the Steering Grip.
10. Observe hands – Look for white knuckles and clenched hands. Instruct the rider to use “light hands” or a “gentle grip” Explain that the Handlebar is only a place to rest your hands- not intended as a lever to move the Segway HT forward or backward.
11. While lightly holding the Handlebar /Control Shaft, instruct the rider to roll slowly forward and backward a short distance in both directions, until he finds “neutral” on the Segway HT. Explain that when the rider can find a position centered over the wheels, the Segway HT will remain stationary.
12. Step to the Steering Grip side of the Segway HT, and instruct the rider to move forward and backward at a controlled speed.

---

**Note:** Evaluate the rider's ability: Over-zealous/under-skilled? Timid? Physically challenged? Awkward? Determine the cause of any riding difficulty and correct.

---
13. Instruct the rider to GENTLY twist the Steering Grip without moving forward or backward. Encourage the rider to turn a full 360° in place, both directions without moving forward or backward.

---

**Explain:** “Now, we’ll take a turn around the cones. I want you to remember three things every time you ride: **“Calm, Controlled, Courteous.”** This is the mantra we would like running through the mind of every rider on a Segway HT!”

---

14. Walk beside the rider and direct her to maintain speed control, as she rides around the cones.
15. Ask the rider to stop.
16. Stand in front of Segway HT, and grip the Handlebar/Control Shaft firmly.
17. Instruct the rider to step down, off the Platform, as if stepping off a stair or steep ladder.

**Repeat** all of above for next rider.

**Maintain** a position of control at all times by walking beside the Segway HT within a bent-arm’s length of the Handlebar/Control Shaft.

**Reinforce** proper stance, foot position and light hands.

## Riding Form

Your posture and stance have a significant effect on your ability to handle various terrain features and surface conditions.

- > Be alert and look ahead – your eyes are a valuable tool for handling terrain features and uneven terrain.
- > Look ahead but maintain the ability to see the Display when glancing down.
- > Keep your legs and arms loose – this helps you absorb vibration or bumps. Do not lock your knees.
- > Use a light grip on the Handlebar, don’t hold too tightly – expect some side-to-side motion on bumpy terrain.
- > Don’t lean over or into the Handlebar.

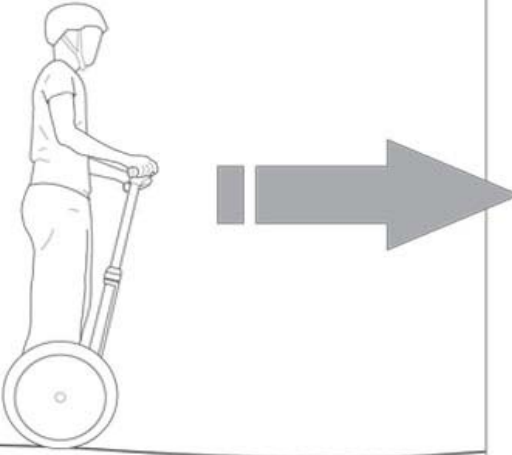

## Parking Stand Deployment and Retraction (i Series only)

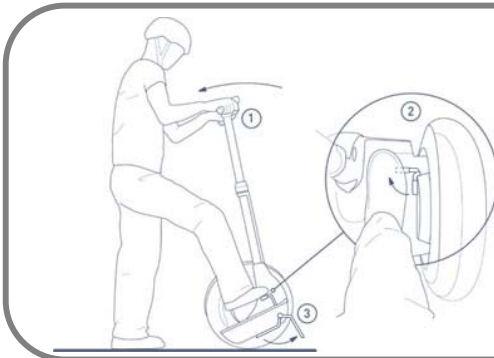

Tilt the Segway HT back toward you to give clearance for the Parking Stand to retract or deploy.

Remember, your Parking Stand should NEVER be deployed when the power is on. Do not start the Segway HT or stand on it until the Parking Stand is retracted.

## Using the Keys

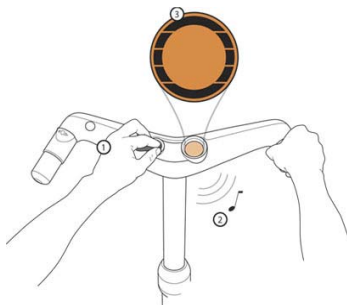

Make contact between the metal pad on the key and the center contact and one outside contact. Do NOT push down to make contact as this can result in damage to both the Key and the Key Port. Instead, rest the Key in a Key Port until you hear the tone indicating that contact has been made.

Remove the Key when you hear the tone or see the Display light up.

## Stepping On – i and p Series



### Ready

- > Segway HT is turned on.
- > The Mode Button has been pressed to enter Balance Mode.



### Step on

- > Look at the Display to make sure it has a green smiling face.
- > Hold the Grips (do not twist the Steering Grip)
- > Put one foot on the Platform.
- > Listen for the tone.
- > Put other foot onto Platform.

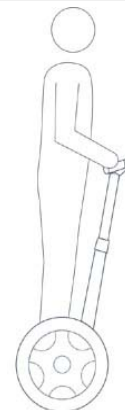

### Ride

- > Look ahead.

## Stepping On – e Series

The e Series Segway HT has been designed for operators who need to carry cargo and who need to get on and off without turning off the Segway HT. These features are combined into a feature called the “E-Stand” or electronic Parking Stand.



### Ready

- > Segway HT is turned on.
- > The Mode Button has been pressed to enter Balance Mode.



### Step on

- Make sure Display is green and smiling.
1. Gently pull Segway HT back until Platform is level.
  2. Put one foot on the Platform.
  3. Listen for the tone.
  4. Put other foot onto Platform
- OR-----
1. Place hands on hand grips, but don't push or pull
  2. Gently place one foot onto Platform to activate Rider Detect Sensors.
  3. Listen for the tone and wait for Platform to level itself.
  4. Put other foot onto Platform.

-----  
Keep the Steering Grip centered



### Ride

- > Look ahead.

The e Series Segway HT has two operating functions while balancing: E-Stand and Ride.

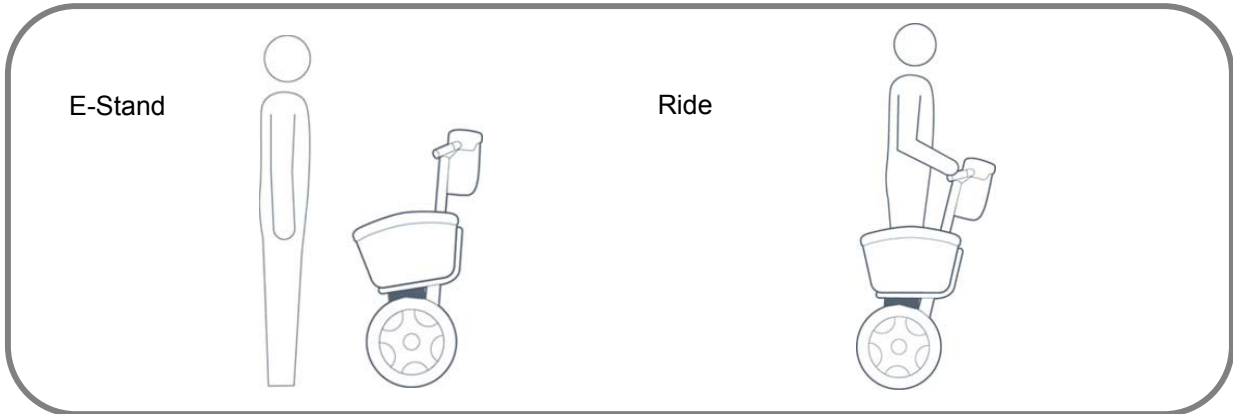

The operation of the e Series Segway HT is different from the i and p Series Segway HT in the following ways:

- > Stepping on - Entry to Balance Mode for riding
- > Stepping off - Entry to E-Stand Mode

To step off, the rider steps down, off the Platform, one foot at a time. The rider must hold onto the Segway HT until the Segway HT shifts into E-Stand, then gently release the Segway HT.

---

**Option:** If you have trouble releasing into E-Stand when holding the Grips, transfer your hold to the Control Shaft, and release the Segway HT into E-Stand from that hold.

---

- > The rider must hold onto the Segway HT until it is in E-Stand (park).  
Instructor: Holding the Control Shaft while the rider steps off an e Series Segway HT can mitigate undesirable movement accidentally delivered by the rider.
- > Failure to hold onto the Segway HT will result in the Segway HT moving unexpectedly.

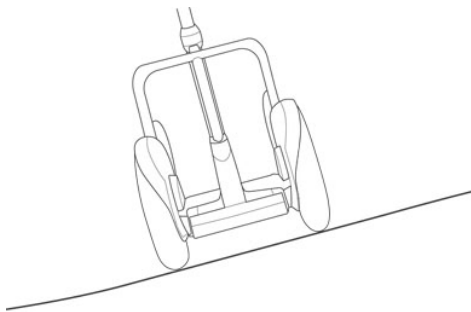

It is possible to use the E-Stand on uneven surfaces. On a hill, in order to engage E-Stand, you must turn the Segway HT to face perpendicular to the direction of the slope (across the “fall-line”).

Wind creates the same affect as a hill. Turn the Segway HT perpendicular to the wind, so it will not be blown backward or forward.

---

**Important:** The e Series Segway HT uses specially designed bags for proper weight distribution and requires those bags for proper, safe operation. Never operate an e Series Segway HT without the Segway cargo bags. Do not use any other bags than those specifically designed for the Segway HT.

---

## Turning

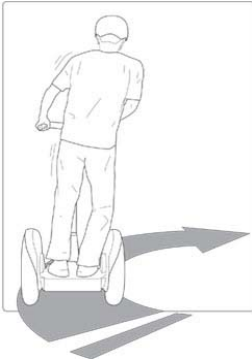

It is important to lean into turns, because the rider must provide dynamic lateral stability to the Segway HT. Leaning into the turn improves lateral stability.

## Loading and Unloading Cargo (e Series only)

There are three bags on the e Series Segway HT. The recommended cargo loading for the bags is:

Front Bag	10 lbs (4.5 kg) maximum
Side Bags	30 lbs (13.6 kg) maximum per bag

Just like a person, a balancing Segway HT may move slightly when cargo is removed or added.

- > The front bag should only be used for lightweight items - An overloaded front bag can negatively impact the balancing system and make it difficult to use E-Stand.
- > Place heavier items in the side bags.
- > Add and remove large items slowly.
- > **Always** load the front bag last, and unload it first, to make balancing the Segway HT in E-Stand easier.
- > Since the e Series model tilts back when engaging E-Stand, your cargo, particularly in the side bags, can shift. Shifting cargo can make E-Stand difficult to engage. Secure your cargo inside the bags.

# Drills

Following is a description of the drills you will practice in this session.

The instructor will demonstrate the skills and then ask participants to practice each skill.

Participants will have only ridden on a Beginner Key (black).

Before continuing, you will need to spend a few minutes with each participant, in order to transition him to a Sidewalk Key (Yellow). You will need to take one-on-one time with each participant as you to introduce the participant to the faster steering control.

Have each rider turn in place with the new Key. Start slowly, then ask them to try turning with full input to the Steering Grip so they are aware of the full turning potential. Then, ask them to jerk the Steering Grip, as though they had done it accidentally. This shows the rider the resultant motion when erratically twisting the Steering Grip. Emphasize that steering should be handled smoothly and gently. The rider should not steer to avoid an obstacle; instead, he should slow down, and then turn.

## Drill #1: Operational Model

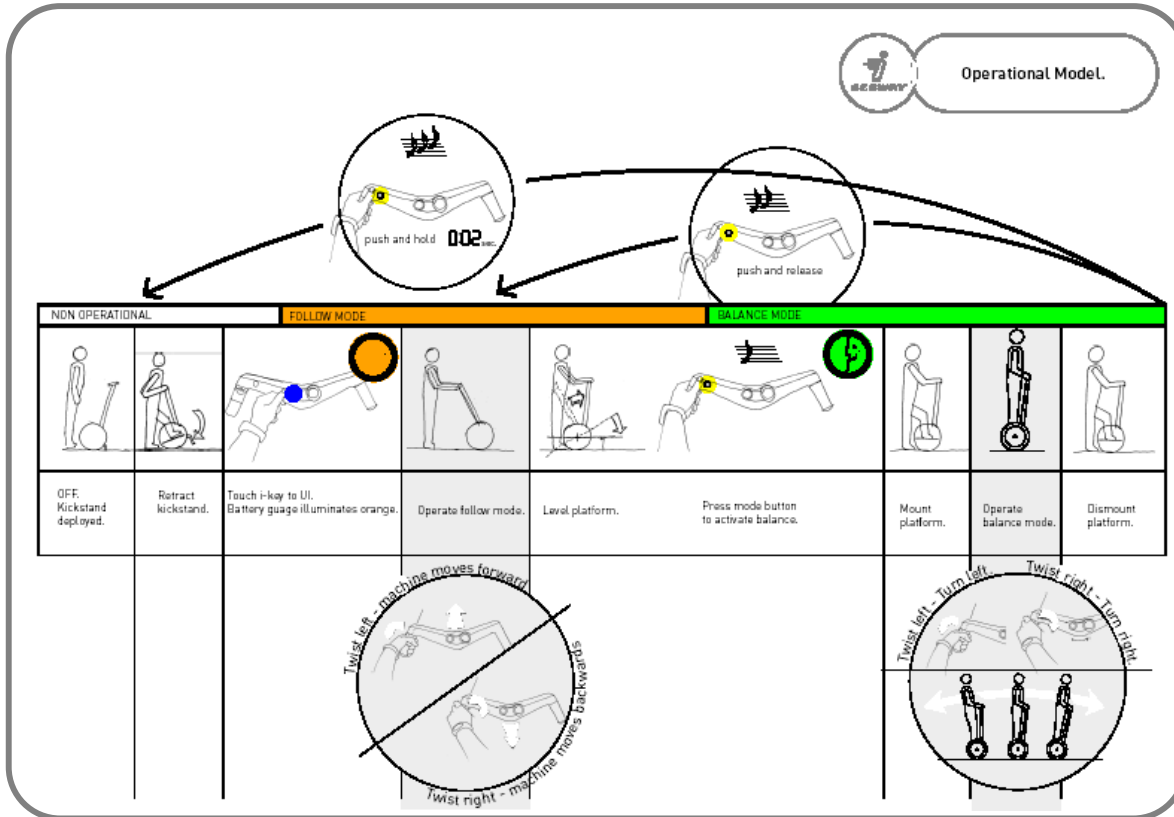

### 1. Parking stand retracted (i Series only)

- a. **Set up** Segway HTs in a line in an open space. Segway HTs should be off with Parking Stand deployed.
- b. **Ask** each participant to stand behind a Segway HT.
- c. **Demonstrate** how to retract Parking Stand. Discuss that no one should ever stand on a Segway HT with a deployed Parking Stand – it will break, as it is intended to break for safety reasons.

- d. **Ask** the participants to retract and deploy the Parking Stand
2. Turn on the Segway HT.
    - a. **Instruct** riders to start Segway HT with Sidewalk Key
    - b. **Provide** tips (don't push key in, tip it sideways to make contact with center and edge, twist key around the port.)
    - c. **Show** the riders how to properly make key contact with the center and one outside contact point on the Handlebar port – best achieved by making sure that the key is parallel to the port upon contact.
    - d. **Explain** that the key should be parallel to the port. Another method is to tilt the key, and see that the edge touches the center and one outside contact. With this method, it is easier to see the contact being made.
    - e. **Instruct** riders not to press the key in too hard. Explain that this could ruin the key and or the connector. If riders find themselves thinking they need to press hard, let them know that it does not necessarily activate due to pressure, but rather due to the contact points. Instruct riders to rotate the key until contact is made with the connectors.
  3. Tap Mode Button to change from Power Assist to Balance Mode.
    - a. **Stand** with each rider down the line as they turn on their Segway HT. Once the Segway HT is on, ask them to tap the Mode Button once to put the Segway HT into Balance Mode.
    - b. **Work** your way down the line until each rider has had the opportunity to turn on their Segway HT in front of you – and you should guide them as to how to put the Segway HT into Balance Mode from Power Assist Mode (*for this first time, particularly because some riders may need more help if they are riding an e Segway HT*).
    - c. Have each rider concentrating on standing in place while on the Segway HT as you walk down the line with other rider. They can also practice stepping on and stepping off.
  4. Check Display to ensure green smiling icon is showing and battery charge level is full enough for operation.
  5. Step on the Segway HT using following procedures:
    - a. **Stand** at each Segway HT as the rider steps on for the first time.
    - b. **Instruct** the rider to twist the Steering Grip while remaining in place, to expose her to the advanced steering sensitivity on the new Key.
 

**i and p Series** - Hold both grips. Step on with one foot, wait for tone, then step up with the other foot.

**e Series** -

Option 1: Grasp Segway HT gently holding both grips, pull Segway HT toward you on a horizontal plane, bring toward you until Platform is level, but NOT leaning down away from you. Don't twist or pull the Handlebar up or down. Step on with one foot, wait for tone, then place other foot on the Platform.

Option 2: Hold Grips, but don't push or pull. Step on with one foot, wait one second until Platform levels, wait for tone, then step on with other foot
    - c. **After** each participant is on the Segway HT, stand in front of the group (they should be in a line) and ask them to face you and stand still. (If there is a participant who seems uncomfortable or unstable on the Segway HT, please make sure that you communicate with her individually. You may need to stand with her while going through these exercises.
    - d. **Demonstrate** to the group that there is a difference between stepping back and moving backwards – but show them that it can be a subtle difference. Stand on the Segway HT so that the group in line can see your profile. Show how you lean to move backwards. Show how you don't lean but step **DOWN** off Segway HT. Tell riders to keep the Platform level and not to pull back on the Handlebar as they are stepping down.
    - e. **Ask** participants to slowly move backwards so that they can feel what you mean about moving backwards. Ask them to move forwards and return to their line formation.
    - f. **Instruct** the participants to drop their left hands by their sides. Explain that this is helpful in stepping off (for beginners) as it helps to shift a rider's center of balance or accidentally turning while stepping off.

- g. **Ask** them to step **down** to step off the Segway HT – while holding the Segway HT with their right hands. Tell them that it does not matter which foot they step off with first – whichever is more comfortable.
- h. Now ask them to hold onto the Handlebar with both hands, but loosely.

---

**Important:** Remind riders to look at the Display and note the icons that they are reading. If the Display shows that the Segway HT is still balancing, it is okay to get back on again.

---

- i. Using the proper technique for an e Series or an i Series, **ask** riders to step on with one foot – keeping an even balance of weight between the foot that is on the Platform and the foot that is on the ground. Tell them “Do not commit all of your weight onto the Segway HT.” When they feel ready, ask them to step up with their other foot onto the Segway HT.
- j. If participants are oscillating, **remind** them that perhaps they might want to check their posture, look ahead, or they might want to move their feet around so that they can stand still.
- k. Repeat stepping on/stepping off 5 to 10 times.

6. Ride forward to end zone.

7. Stop within end zone (4 feet).

Participants should be in line formation.

- a. Turn on Segway HTs and properly step on.
- b. **Instruct** them to move slowly toward you and to stop when they get to you (you should be standing about 10 feet from their starting point). It helps to have a line across the floor or a few cones for this exercise so that riders can try to learn to stop in a specific place.
- c. **Tell** riders to concentrate on feeling how they need to shift their weight to stop.

---

**Note:** If some riders have trouble stopping, work with them individually and try to use different ways of explaining – such as: shifting weight to evenly across the feet, almost sitting down and then standing up again to stop, or even just straightening out their posture.

---

- d. Now that riders know how to stop slowly, have them get back in a line and ask them to come forward and stop only when you ask them to do so.
- e. Repeat 5 to 10 times.

8. Turn 180 degrees.

9. Ride to starting line.

10. Stop.

11. Turn 180 degrees.

12. Step off the Segway HT using the following procedures:

- > **e Series** - Step down with one foot. Then step down with the other while continuing to hold at least one grip or the Control Shaft gently. Don't pull Segway HT toward you or push it away. Release Segway HT gently into E-Stand by guiding it into or very near it's desired orientation.
- > **i and p Series** - Hold one or both grips. Step down with one foot, then the other. Continue to hold Segway HT.

13. Tap the Mode Button to put the Segway HT into Power Assist Mode.

- a. **Ask** the riders to line up, step off the Segway HT and stand behind their Segway HT.
- b. **Instruct** them to press the Mode Button once and to listen to the tone (if they are not in a noisy place) and to notice the difference in the Segway HT's behavior before the button was pressed versus after (balancing and not balancing).

- c. **Instruct** riders to level the Platform (i and p Series) or align the Control Shaft vertically (e Series) and tap the Mode Button once again. (Make sure that e Series riders know that they are about to engage E-Stand.)
  - d. **Ask** riders to step onto their Segway HTs.
  - e. **Ask** riders to tap the button while they are standing on the Segway HT – some riders may need reassurance that nothing is going to happen to them, so you may want to demonstrate this first.
  - f. **Explain** that the Mode Button is smart and responds to the Rider Detect Sensors. It is designed not to switch modes while a rider is on the Segway HT, as this would not be safe.
  - g. **Ask** riders to step off and put the Segway HT in Power Assist Mode. Tell riders that if the Segway HT is in Power Assist Mode for 60 seconds no input to the Steering Grip; the Segway HT will automatically shut off to save power.
  - h. **Show** them to protect the fenders by always using Power Assist Mode by walking around to the front of the Handlebar. This gives greater clearance to the fenders.
  - i. **Explain** to them that initially it might not be intuitive as to how to power the Segway HT forwards (moving in front of you) and backwards (moving in to you).
  - j. **Have** riders practice twisting the Steering Grip GENTLY, and carefully so they don't power the Segway HT quickly in any direction – especially toward their shins.
  - k. **After** the riders have moved around in Power Assist Mode, ask them to turn off the Segway HTs (Parking Stand down for i Series). Talk to them about the **different uses** for Power Assist Mode which they will get to experience later:
    - > Up a curb or ramp (perhaps into a vehicle)
    - > Powering up and down stairs
    - > Over rough terrain or steep slopes
  - l. **Emphasize** that the rider should always:
    - > Stand and guide from the front of the Segway HT, to protect fenders
    - > Keep the weight of the Segway HT below them on any slope (up or down)
    - > Gently twist the Steering Grip to avoid tugging yourself or powering the Segway HT into your legs
14. Press Mode Button for approximately two seconds- until you see sleepy face icon. Release Mode Button.
  15. Deploy Parking Stand (i Series only).

## Drill #2: Controlled Stop

Avoid having to stop too quickly by assessing your speed and any obstruction that would require you to stop. Anticipate pedestrians, animals and cars, especially when passing a side street, path, or row of shops. Be aware that you can stop too quickly on the Segway HT resulting in loss of traction and potentially falls, injury and damage to the Segway HT.

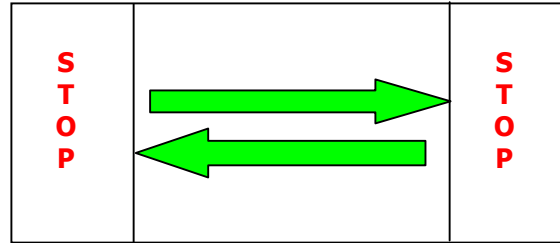

1. Speed control  
Moving forward a short distance, and shift weight back until stopped. If the wheels squeak or spin, you have exceeded the limits and you need to reduce their stopping speed. Avoid aggressive stopping.
2. Contiguous smooth acceleration and stops  
Start slow and stop in end zone. Incrementally increase speed until rider has a gauge about how fast he can stop safely at the given speed. Work on technique, not speed. Work on building knowledge, not exceeding limits.
3. Practice control and commitment  
If rider continues to roll forward after s/he intends to stop, then commitment was lacking. Work on moving weight back until Segway HT actually reverses direction, then immediately stand up.

If you hear squeaks, see spinning, tell the rider that s/he has exceeded limits and needs to reduce either their riding speed or stopping speed (or both).

## Drill #3: Slow-Stops and Turns

1. Move forward.
2. Stop.
3. Turn 180 degrees.
4. Repeat.
5. Stop before cone - do not hit it.

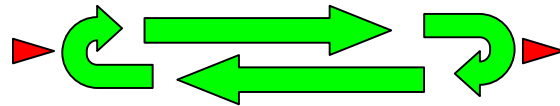

This drill gets riders used to twisting the Steering Grip gently and smoothly. Work on one motion at a time – move forward, stop, *and then* turn. Focus on smooth turns and wrist motion.

## Drill #4: Leaning Loop Turns

1. Move forward in a continuous motion around cones while turning – do not hit it.
2. Practice leaning into turn.
3. Do not exceed “end zone” line.
4. Reverse direction.

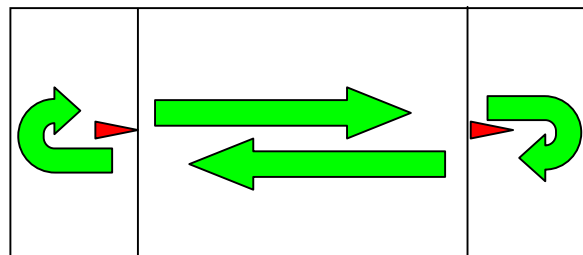

This drill transitions riders into using their body weight to laterally stabilize Segway HTs. Focus on coaching riders to put weight on **inside** leg/foot – lean onto the turn, bend inside knee and inside arm, keep shoulders square. This drill combines motions, simultaneously moving forward *while* turning.

## Drill #5: Loose and Tight Slalom

1. Turn around cones placed at 12-foot (4 meter) intervals
2. Practice leaning into turn and maintaining a continuous motion
3. Practice narrowing the approach.
4. Do not exceed "end zone" line.
5. After 5-10 repetitions, tighten the cones to 6-foot (2 meter) intervals.

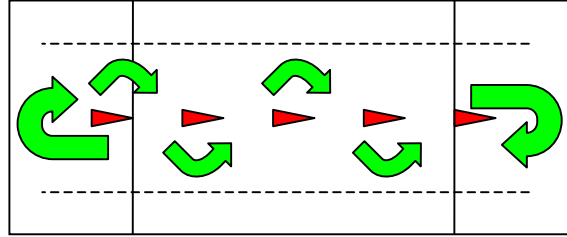

This drill helps riders practice turning smoothly at speed, leaning into turns, varying left and right steering movements and varying forward speed. Focus on speed control, continuous smooth acceleration and turns, not exceeding end and side zones, or hitting cones

## Drill #6: Straight Funnel

1. Approach cones that are just slightly wider than Segway HT footprint.
2. Do not touch any cones.
3. Ride slowly and concentrate on technique, not speed.

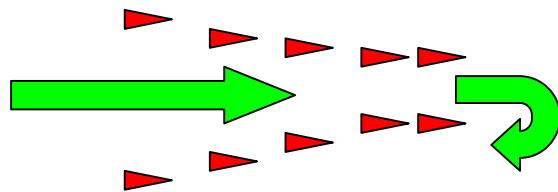

This drill is important in exposing riders to the width of the Segway HT's wheelbase, so they can use good judgment in narrow places (doorways, sidewalks, between cars, in manufacturing plants).

## Display Messages



The Display on the Handlebar indicates the following information:

- > The operational mode: Power Assist Mode or Balance Mode or Off
- > The battery charge level
- > Faults
- > User errors

## Display Colors





Green (and only green) means you may step on and ride in Balance Mode. Orange indicates Power Assist Mode. Red means something is wrong.

If the Display is in direct sunlight, it may be difficult to see the color. Try shading the Display with your hand.

If the Display is not illuminated, the Segway HT is not powered on.



## Normal Operation







The following Display icons should appear each time you power on your Segway HT.

Display Icon	Definition	User Response
	Startup test being performed. (All segments should be displayed, with no backlight).	Wait before attempting to use the Segway HT.
	Segway HT is in Power Assist Mode (full battery charge level indicator shown).	Do NOT attempt to step on the Segway HT. It is not in Balance Mode. Rotate Steering Grip to move the Segway HT forward and back.
	Segway HT is in Balance Mode (full battery charge level indicator shown).	You may step on and ride the Segway HT.
	Segway HT is shutting down (approximately one-half battery charge level indicator shown). This icon should only appear when you power off.	Do not attempt to power on until orange backlight disappears. (In cold weather, it may take several seconds for this icon to disappear.)

## Error Conditions During Startup

If you attempt to power on your Segway HT, but the Segway HT detects a condition that precludes power on, one of the following icons will appear in the Display. (The system fault icons described on pages 45 may also appear.) All of these icons are red. You may clear these conditions with the appropriate User Response described below. Do not attempt to step on the Segway HT until you have cleared the error condition and you have confirmed that the Segway HT is in Balance Mode

Display Icon	Definition	User Response
	The Key being used to start this Segway HT does not contain the correct security code.	Restart using correct Key. If condition continues, contact Segway at <a href="mailto:customeroperations@segway.com">customeroperations@segway.com</a> or call 1-866-4SEGWAY (1-866-473-4929).
	The Segway HT is plugged in.	Unplug the Power Cord and, if the Segway HT has powered off, power on again.
	The Battery Packs are too low to allow safe operation of the Segway HT.	Charge the Battery Packs; then attempt to power on.

Display Icon	Definition	User Response
	The Steering Grip is turned to the left at startup.	Be sure your hand is not turning the Steering Grip. Gently move the grip to ensure it is in the center (straight-ahead) position.
	The Steering Grip is turned to the right at startup.	
	Right rear Rider Detect Sensor is engaged at startup.	Make sure your foot is not on the Platform when powering on the Segway HT. Check your Mat to ensure it is clear of foreign objects. If necessary, remove the Mat and inspect beneath it.
	Right front Rider Detect Sensor is engaged at startup.	
	Left front Rider Detect Sensor is engaged at startup.	
	Left rear Rider Detect Sensor is engaged at startup.	

## Reduced Performance Levels

The following Display icon (note that the face is not smiling) will appear if the Segway HT is operating at reduced performance levels due to a temporary condition. These conditions include: riding up a steep hill, riding on bumpy terrain, low Battery Pack charge, riding down a hill with fully charged Battery Packs, the first few seconds after power on, inadequate foot pressure on the Platform, or the Battery Packs are too hot or too cold.

If you feel the Speed Limiter push the Handlebar back, stop leaning forward and slow down. You should always leave a gap between yourself and the Handlebar. Riding against the Handlebar can cause loss of control, collisions, falls and injury.

Display Icon	Definition	User Response
	The Segway HT is operating at reduced performance levels due to a temporary condition (full battery charge level indicator shown).	Do not try to lean over the Handlebar to override the speed limit, which has been lowered until the condition clears.

## Critical Faults During Balance

If, during normal riding, the system detects a critical system fault, it will perform a Safety Shutdown by reducing speed to zero and giving the Stick Shake Warning. At that time, the Display will show the following icon:

Display Icon	Definition	User Response
	<p>The system has detected a critical error and is slowing to zero speed before Safety Shutdown (full Battery Pack charge level indicator shown).</p>	<p>Come to a controlled stop, then step off and discontinue operation. You have 10 seconds from the start of the Stick Shake Warning to come to a controlled stop and safely step off before the HT will automatically shutdown.</p>





Never Restart After an Empty Battery Condition Notification. The Segway HT will notify the rider of an empty Battery Pack condition. (A red “unhappy face” icon will appear in the Display, the Segway HT’s speed will be limited to 5 mph (8km/h), and the Handlebar will beep.)

When you receive notification of an empty Battery Pack condition, you should stop, step off, shut down and charge your Segway HT. If you fail to stop and step off of your Segway HT during an empty battery notification, then your Segway HT will perform a Safety Shutdown. (See a detailed description of Safety Shutdown in your Rider’s Guide or e Series manual.)

Never restart and ride your Segway HT after it has notified you of an empty battery condition, until you recharge. There is a high probability that the Segway HT will not have enough power to keep you balanced – especially if you demand a lot of power at once. If you restart and continue riding prior to recharging, you risk falling. Also, you may damage your Battery Packs, resulting in reduced Battery Pack life and capacity.

## System Faults

If the Segway HT detects a fault in the hardware of the Segway HT, one of the following icons (which are red and always displayed together with a wrench icon) will appear in the Display. The Segway HT cannot be used until the fault is cleared. Attempt these steps in the order listed to clear the fault. If you are unsuccessful, contact Segway Customer Support at [www.segway.com](http://www.segway.com) or call 1-866-4SEGWAY (1-866-473-4929).

Display Icon	Definition	User Response
	There is a fault in the rear Battery Pack.	<ol style="list-style-type: none"> <li>1. Remove and reseal the faulted Battery Pack.</li> <li>2. Power on Segway HT.</li> <li>3. If the same icon appears, remove both Battery Packs, reverse locations of the Battery Packs (swap front and rear), and reseal both Battery Packs.</li> <li>4. If, after reversing and resealing the Battery Packs, the same icon appears (indicating that the fault remains in the same Battery Pack location), then check and make sure the two cable connectors are properly connected. Then power on the Segway HT. If the same icon appears, contact Segway at <a href="mailto:customeroperations@segway.com">customeroperations@segway.com</a> or call 1-866-4SEGWAY (1-866-473-4929).</li> </ol>
	There is a fault in the front Battery Pack.	<ol style="list-style-type: none"> <li>5. If, after reversing and resealing the Battery Packs, the icon changes to indicate that the fault is now in the other Battery Pack location, then contact Segway at <a href="mailto:customeroperations@segway.com">customeroperations@segway.com</a> or call 1-866-4SEGWAY (1-866-473-4929) to order a new Battery Pack.</li> <li>6. Because the Segway HT performs at the level of the lesser Battery Pack, whenever you replace a Battery Pack, consider replacing both Battery Packs, depending upon the age of the non-fault Battery Pack.</li> </ol>
	There is a fault in the Platform.	<ol style="list-style-type: none"> <li>1. Remove and reseal both Battery Packs.</li> <li>2. Power on Segway HT.</li> <li>3. If same icon appears, check and make sure the two cable connectors are properly connected.</li> </ol>
	There is an unidentified fault in the Segway HT.	<ol style="list-style-type: none"> <li>4. Power on the Segway HT. If the same icon appears, contact Segway Customer Operations at <a href="mailto:customeroperations@segway.com">customeroperations@segway.com</a> or call 1-866-4SEGWAY (1-866-473-4929).</li> </ol>

## Display ID Instructions

**Say:** “This is an exercise to help you become familiar with how the Display on the Segway HT communicates with you through icons. Match up the Display icon with the appropriate description. Mark the number of the description in the box with the Display icon. Let’s do the first one together.”

**Point** to the Display icon in box 1A. Ask which number definition in the Workbook corresponds to the Display icon. Have participants write the number of that description in the shaded triangle.



**Direct** the participants to work in groups of 2 or 3, and encourage them to interact with each other.

**Optional: Explain:** “Now, I am going to split the group. Both groups will participate in Display ID and ride, just at different times.”

Now, break the group into two parts, if there are more than 6 participants.  
 Ask the participants to go around the room counting off A – B – A – B – A – B, etc.  
 Say, “Group A, come with me for the first ride, Group B, stay here and complete this exercise.”

Say to Group B: “You can work in groups of 2-3. When you have finished, you can take a break. Be sure to meet back here at **XXX** time.”

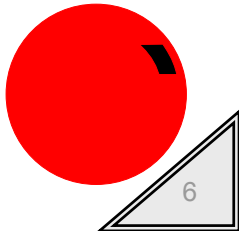
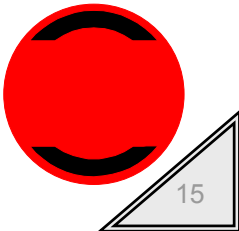
## Display ID

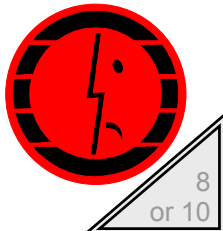
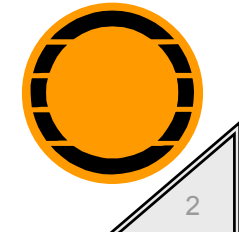
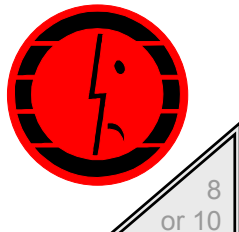
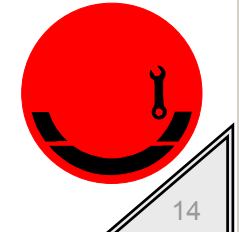
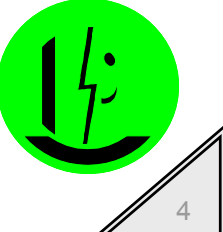
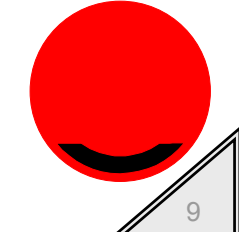
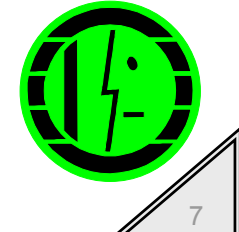
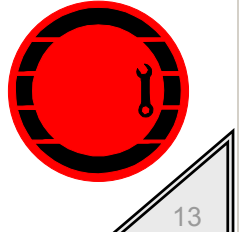
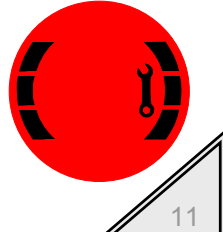
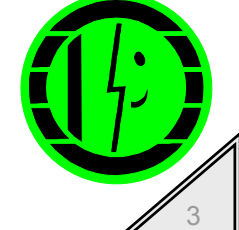
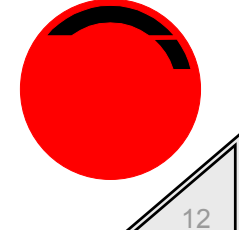
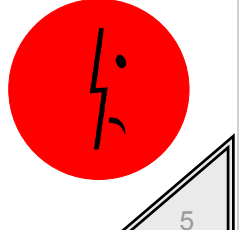
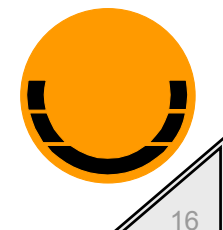
	A	B	C	D
1				
2				
3				
4				

<p><b>(1)</b> Startup test being performed. Do not step on.</p>	<p><b>(2)</b> Power Assist Mode. Full Battery Packs. Do not step on.</p>	<p><b>(3)</b> Balance mode. Full Battery Packs. OK to step on.</p>	<p><b>(4)</b> Balance mode. Battery Packs at 20%. Recharge at next available opportunity.</p>
<p><b>(5)</b> Slow to a stop and step off. Battery packs too low to allow continued operation. Segway HT will perform a Safety Shutdown.</p>	<p><b>(6)</b> Right front Rider Detect Sensor is engaged at startup. Clear Mat. Remove weight from Platform.</p>	<p><b>(7)</b> The Segway HT is operating at reduced performance levels due to a temporary condition. Slow down. Do <b>not</b> try to ride through Speed Limiter.</p>	<p><b>(8)</b> The Key being used to start this Segway HT does not contain the correct security code. Restart using correct key. If condition continues, contact Segway LLC.</p>
<p><b>(9)</b> Do not step on. The Battery Packs are too low to allow safe operation of the Segway HT. Charge your Battery Packs for several hours.</p>	<p><b>(10)</b> The Platform is not level when you try to change from Power Assist to Balance mode (i and p Series), or the Control Shaft is not vertical (e Series). Orient correctly. Tap Mode Button to set Balance mode.</p>	<p><b>(11)</b> There is an unknown fault in the <b>system</b>. Check connectors between Control Shaft and Platform, and check Battery Pack connections. If fault does not clear, call Service.</p>	<p><b>(12)</b> The Steering Grip is turned to the right at startup. Make sure the Steering Grip is centered, and remove hand.</p>
<p><b>(13)</b> There is an unknown fault in the <b>Platform</b>. This is most likely a critical component or connection failure. Call Service.</p>	<p><b>(14)</b> There is a fault in the rear Battery Pack. Be sure it is properly connected using all four screws.</p>	<p><b>(15)</b> The Power Cord is plugged in to the Segway HT. Unplug, and wait for display to change. Restart.</p>	<p><b>(16)</b> Power Assist Mode. Battery Packs at 60%.</p>

## Summary

Generally, what do the colors; Green, Orange and Red indicate? Classify the actions to take, dependent only on the color in the Display.

<b>Green</b>	<b>Orange</b>	<b>Red</b>
Ok to proceed.	Do not step on.	Error condition, step off in a controlled manner or do not step on.

Describe the expressions of the faces in the Display. What are they telling you?

<b>Smile</b>	<b>Straight-faced</b>	<b>Frown</b>
Happy: all systems go.	Concerned: Reduced performance. Slow down, proceed with caution.	Unhappy: Error condition detected. Step off in a controlled manner or do not step on.

**1. Do not attempt to restart the Segway HT until...(finish the sentence)**

The Display completely fades. Analogy: Don't press your start button on your pc after you turn it off, until it has completed it's shutdown cycle.

**2. How do you start the Segway HT?**

Start the Segway HT with the key – not with the Mode Button.

**3. How do you turn off the Segway HT?**

Turn off the Segway HT with the Mode Button. Hold it down for 2 seconds. Rider must be off the Platform before the 2 seconds begin.

**4. How do you change from Power Assist Mode to Balance Mode?**

Change modes with the Mode Button. Tap the Mode Button once to change from Power Assist to Balance Mode, and vice versa.

**5. Why might you get a red frown when changing from Power Assist Mode to Balance Mode?**

I might get a red frown when changing into Balance Mode because

- My i-Series Segway HT does not have a level Platform, or
- My e-Series Segway HT does not have a vertical Control Shaft.

**6. Can you ever ride the Segway HT in Power Assist Mode?**

No.

**7. What Display should you see BEFORE you step onto the Segway HT?**

You should see a green smiling face with multiple battery segments.

**8. In Power Assist Mode, turning the Steering Grip will result in what motion?**

The Steering Grip will move the Segway HT forward and backward while in Power Assist Mode. Keep your shins clear of the Segway HT.

## > Session 4 Safety Features

<b>Who.</b>	Entire group
<b>What.</b>	Demonstrate product design features. Allow each participant to experience each one.
<b>Where.</b>	Riding space
<b>Method.</b>	Observation and experiential learning—watching and riding the Segway HT

### Timing

Total Time

45 min

### Introduction

In this session, the riders will be introduced to the design features of the Segway HT. They will see examples of features being induced by the instructor. Class discussion will focus on appropriate responses to Segway HT alerts.

### Objectives

***Upon completion of this session the rider should be able to:***

- > Explain the role of redundant systems
- > List design features that enhance rider safety
- > Describe appropriate actions to take when the Speed Limiter activates
- > Describe appropriate actions to take when the Stick Shake Warning triggers
- > Describe appropriate actions to take when Segway HT perform a Safety Shutdown.

### Topics

***The following topics will be covered in this session:***

- > Overview of Product Design Features
- > Speed Limiter
- > Rider Detection
- > Safety Shutdown
- > Torque and Traction
- > Effect of Tire Pressure
- > Safe lifting techniques
- > Summary

## Overview of Product Design and Safety Features

The Segway HT has been designed with the utmost concern for the safety of the operator and those who may be nearby. Backup systems have been designed to maintain controlled operation of the system in the unlikely event of a component malfunction.

### Redundant Systems

- > **Controller Boards**  
Controller boards are interchangeable front and rear. They are connected to the Control Shaft cords, the Balance Sensor Assembly, the Battery Packs and the motors in such a way that if there is a malfunction in any of these components, or the connections between them, the Segway HT will perform a Safety Shutdown (see description below)
- > **Motors**

The motor for each wheel (right/left) is connected to the front and rear drive systems. This allows either the front or the rear drive system to produce torque to the motor shaft. The system uses independent controllers for the front and rear drive systems. Like the Battery Packs, the redundant capability ensures functionality in the unlikely case of a module failure.

#### > **Battery Packs**

The Battery Packs in the HT are sealed units that require no maintenance besides proper charging. There is a front Battery Pack and a rear Battery Pack. The Battery Packs are interchangeable. The Segway HT will be brought to a stop safely using just one Battery Pack should a problem occur in the other Battery Pack. The Battery Packs are utilized so that they provide the highest possible range while maintaining the appropriate capability to handle any system issues. You should always replace the Battery Packs in pairs.

#### > **Balance Sensor Assembly (BSA)**

There are five gyroscopes (rate sensors) and two tilt sensors in the BSA. They gather information about the orientation of the Platform in all three planes (pitch, roll and yaw.) It is this information that is used to determine Segway HT behaviors resulting in moving the wheels under the Platform to maintain balance.

In Balance Mode, all five rate sensors (gyros) are actively being used. They are constantly checking each other to ensure each is operating correctly. If one of the five rate sensors fails, a Safety Shutdown will occur. Additionally the two tilt sensors are checking each other in a similar manner.

#### > **Systems in the Handlebar**

There are redundant communication systems in the Handlebar, each backing up the Steering Grip and the Mode Button. If there is a malfunction in either the Steering Grip or the Mode Button, the Segway HT will perform a Safety Shutdown. Each system in the Handlebar independently communicates information to the Controller Boards in the power base via an individual Control Shaft cable. If either cable has a malfunction, the Segway HT will perform a Safety Shutdown (See “Safety Shutdown” on page 58).

## **Operator Responsibilities**

The HT will reduce available speed of the Segway HT when its capabilities are reduced. If a critical system malfunctions, the HT performs a Safety Shutdown (see description below).

**Say:** “For your safety and the safety of those around you, it is important that you be able to recognize all safety critical alerts and behaviors on the Segway HT, and to respond properly.”

- You, the operator, determine where the Segway HT will be used, and how it will be used. Always exercise awareness, know your capabilities, and respond to Segway HT alerts and behaviors.
- Walking is easy and safe, within your capabilities, but how many people have inadvertently walked into a parking meter, slipped on a slippery driveway, twisted their ankles on a curb or tripped going down the stairs?
- You must use good judgment!

The Segway HT has a depth of utility that you will have to become adept at mastering, just like driving a car in heavy traffic.

**Say:** “It’s easy to use, but nothing is obvious to the uninformed”

## **Response Hierarchy**

Draw the following headings (Normal Operation, Reduced Performance, Safety Shutdown) on the white board:

## Normal Operation

### Reduced Performance (transient conditions)

*Speed Limited or reduced to zero:*

- > Fewer than three Rider Detect Sensors depressed
- > Tilt sensors saturated (excessive lateral acceleration or roll angle)
- > System too hot
- > Battery Packs low or not enough power to perform the requested action (riding too fast up or down a hill)
- > Battery Packs too full to accept more energy from regenerative braking while traveling down a hill

### Safety Shutdown (Critical component malfunctions/a failure of any of the following redundant subsystems)

*Deceleration to zero speed, stick shake, red frown display*

- > Battery Packs completely discharged or malfunction
- > Motor
- > Controller Board
- > Balance Sensor Assembly (BSA)
- > Steering Grip or Mode Button
- > System in Handlebar
- > Control Shaft cord
- > Connections between redundant parts

**Draw** an arrow from “Normal Operations” to “Reduced Performance” and another arrow from “Reduced Performance” back to “Normal Operations”

**Say:** When the transient condition ceases to exist, the Segway HT returns to normal operation.

**Draw** an arrow from “Reduced Performance” to “Safety Shutdown.”

**Say:** If the transient condition progresses into a critical malfunction, the Segway HT will perform a Safety Shutdown

**Draw** an arrow from “Normal Operations” to “Safety Shutdown.”

**Say:** In case of a critical component malfunction, the Segway HT will perform a Safety Shutdown.

## Speed Limiter

Like your body, the Segway HT has a top speed. The Segway HT’s top speed is limited by many conditions, including:

- > **The Key used to power on**  
The Key governs the top speed:
- > **Steepness of a hill**  
Reduced capability includes the inability to adequately produce torque and speed depending on the steepness of the hill.
- > **Bumpy terrain**  
If the Balance Sensor Assembly gets dizzy from riding on bumpy terrain or spinning in circles, the Segway HT slows down until the Balance Sensor Assembly can assess the Segway HT’s position correctly. Reduced capability includes the inability to measure inertial data.
- > **Battery Pack charge**  
If Battery Packs are fully charged: When you go downhill the output shaft of the motor spins, generating energy, which is then stored in the Battery Packs and reused next time you require energy. This feature is called **regenerative braking**. If the Battery Packs are at full charge, and you go downhill, the energy being generated has no place to go. The speed limiter engages to slow the Segway HT down so less electricity will be generated.

If Charge is too low: When there is not enough charge in the Battery Packs, Speed Limiter will engage. Analogy: similar to how your muscles work.

- > **The first few seconds after power on**  
Analogy: “Like waking up in the morning.” It takes a few seconds for the Balance Sensor Assembly to assess the orientation of the Segway HT. During this time, the Speed Limiter is engaged.
- > **Foot pressure on the Platform (number of Rider Detect Sensors depressed)**  
when sensor data indicates that the rider is not in the proper position and fewer than three Rider Detect Sensors are depressed, speed limiter will engage.
- > **Battery Pack temperature**  
If the Battery Packs are too hot or too cold, the Segway HT limits speed because less energy is available.

Just like your feet with relation to your body, the Segway HT needs to be able to move its wheels beneath your body to stay balanced, even if the Segway HT has a low battery charge. If you are running on the grass and stumble on a root, your feet need to speed up to get back underneath you. The Segway HT wheels do the same thing. When your Battery Packs are low, just like when your muscles are tired, you need to be more careful and you have a higher risk of falling.

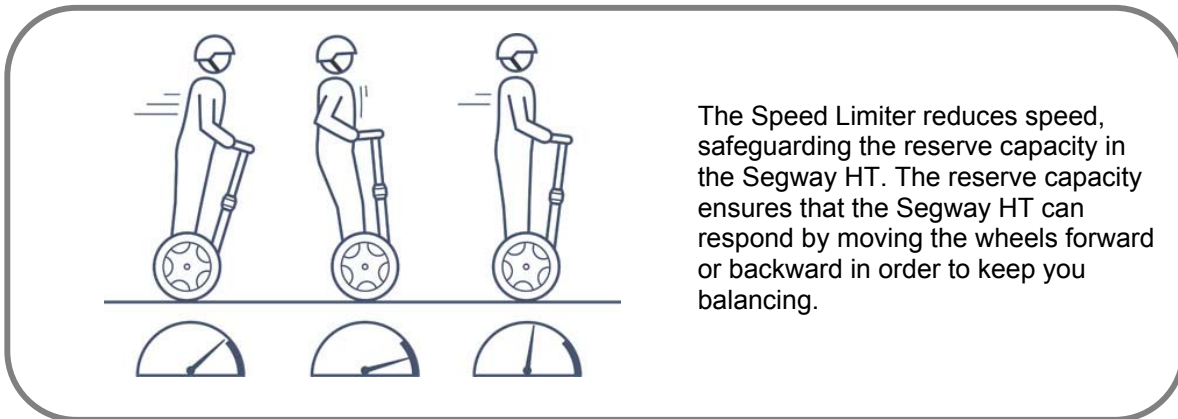

The speed limiter is used to modify the Segway HT's performance dynamically – It allows maximum utilization of the HT in most situations (smooth surfaces, moderate inclines), but reduces the performance if the Segway HT or the environment is making it difficult for the HT to function at its maximum capabilities (steep inclines, low Battery Pack charge, extreme temperatures). The Segway HT communicates that it is limiting the rider's speed kinesthetically – by the sensations you feel in your arms and legs as the Handlebar position is changed and the Platform tilts aft.

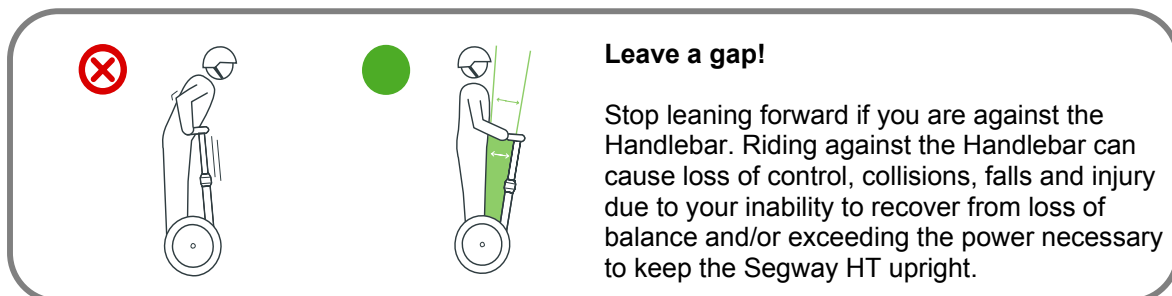

### Leave a gap!

Stop leaning forward if you are against the Handlebar. Riding against the Handlebar can cause loss of control, collisions, falls and injury due to your inability to recover from loss of balance and/or exceeding the power necessary to keep the Segway HT upright.

Attempting to exceed the speed limit results in two **undesirable outcomes**:

- > Posture that is detrimental to safe riding Since the Handlebar is pressed into your torso, your arms and legs are not in an appropriate position. Your legs will generally straighten, as you lean back on your heels due to the aft tilt of the Platform. You will have a difficult time correcting in case of any changes in the terrain, or in your speed.
- > Reduction in range, because of the constant acceleration/deceleration taking place

## Motor Saturation

An electric motor produces torque. The faster it goes, the less torque it can produce. At some point, the motor **“saturates”** which means even if more torque is commanded, more torque is not produced. This is equivalent to “flooring it” in a car. In the HT, the available torque and speed (the **“reserve”**) depend on:

For any dynamically stabilized machine, it is **important** to know where this saturation limit is so that the Segway HT can: **(a)** keep the operator away from this operating point, if possible or **(b)** warn the operator if they approach this operating point

The HT endeavors to **keep the operator away from this limit** by limiting speed. The term “reserve” is used to describe the torque and speed buffer between the current operating point and the capabilities of the drive system. This works when the Segway HT is **moving as opposed to stationary**.



The Display indicates that the Segway HT is reducing performance deliberately by showing a straight-faced icon. The appropriate rider response is to **slow down**. Do not try to lean past the speed limit, which has been lowered until the condition ceases to exist.

### Guide each participant to a Segway HT.

- > **Start** the Segway HT with the Beginner Key (6mph).
- > **Ask** the participants to watch you demonstrate speed limiter.
- > **Tell** them to pay close attention to the Handlebar, the Platform, and your posture.
- > **Exceed** the speed limit for a few seconds so they can see the effects.

One way for the Segway HT to limit speed is to adjust the pitch of the Platform. By tilting the Platform backward, the Segway HT can inhibit forward acceleration by making it difficult for the rider to get his/her center of gravity in front of the contact patch. The Speed Limiter looks at the speed limit and the actual speed and, if the speed is greater than the speed limit, the Segway HT begins to pitch backward. Persistent operation over the speed limit causes this offset angle to increase.

**Run along with one participant at a time, as s/he induces the speed limiter.**

- > **Explain** that you are exposing them to this experience so they will know how to recognize the Segway HT behavior and respond properly.
- > **Emphasize** that the proper response when they feel speed limiter is to SLOW DOWN as much as necessary to regain proper posture. This may mean slowing to a complete stop if the speed limit has been set to zero.
- > **Instruct** the participants NOT to continue normal operations until the speed limiter behavior has been discontinued.

When all participants have experienced the Speed Limiter, have them observe you exceeding the reverse speed limit, and experience stick shake.

**Stick Shake Warning**

**Say:** The expression “stick-shake” comes from airplanes – a pilot’s control stick will vibrate if the plane is near stall. Are there any pilots in here?

One of the ways the Segway HT notifies you that you are at risk of falling is by shaking the Handlebar and making growling noises. This is called the Stick Shake Warning. The Stick Shake Warning will occur if you ride backward too fast or if you demand too much power from the Segway HT, such as by riding on a steep slope, on rough terrain, against an obstacle or by accelerating or decelerating abruptly. Stick Shake Warning is more likely to occur when your Battery Packs are low, cold, heavily used, or poorly maintained. Stick Shake Warning can happen both when you are on and off the Segway HT, as described in the following table:

<b>Action</b>	<b>User Response</b>
Riding aggressively, accelerating or stopping abruptly.	Ease up! Ride more gently, smoothly and slowly.
Riding against the Handlebar.	Ease up! Leave a gap!
Riding on rough terrain or steep slopes.	The terrain is too demanding or steep. Ride on smoother, flatter terrain. If on a slope, turn perpendicular to the slope, step off, and proceed in Power Assist Mode.
Riding against an obstruction.	Stop pushing against the obstruction. Stop, step off, and proceed in Power Assist Mode.
Riding backward.	Stop, turn in place, and proceed forward.
During Safety Shutdown.	Come to a controlled stop and safely step off within 10 seconds.
Moving a Segway HT with no rider on the Platform while in Balance Mode.	When moving your Segway HT in Balance Mode with no rider on the Platform, you must move very slowly, or switch to Power Assist Mode.
Stepping onto a Segway HT Platform while in Power Assist Mode.	Remove your foot. Level the Platform. Tap the Mode Button to enter Balance Mode. Check the Display for the green smiling face. Move the Handlebar to make sure that the wheels respond. Try stepping on again.

**Demonstrate** the reverse speed limiter by going in reverse until you induce stick shake (about 3mph).

**Guide** each participant to step off her Segway HT, enter Power Assist Mode, tilt the Platform backward, and place a foot on the Mat. The Segway HT will give the Stick Shake Warning. Participants have the opportunity to experience this warning in a controlled setting.

#### **Forward versus Backward:**

Having Speed Limiter move the bar forward cannot regulate backward speed. Since it is possible that the rider continues to ride backwards at excessive speed, there is no way to enforce a backward speed limit. In this case, the approach is to give a Stick Shake Warning above a certain speed to **deter** this kind of operation.

#### **Stationary versus Moving:**

In cases where the HT is stationary, it is still possible to demand more torque than the Segway HT can produce. In this case, the Segway HT will stick shake to warn the operator it is at its limit. Some low speed cases where the operator may experience a Stick Shake Warning due to exceeding torque capabilities include:

- > Attempting to ride on/up a terrain which demands too much torque like a steep hill
- > Stopping too abruptly

---

**Note:** During a hard stop, the torque capabilities of the left and right side may not be perfectly matched – this can cause the Segway HT to rotate under a maximum-torque stop.

---

#### **Appropriate Rider Response:**

If you feel the Stick Shake Warning while riding, slow down. If the Stick Shake Warning persists, come to a stop and safely step off.

#### **Rider Detection**

The Segway HT Platform contains four Rider Detect sensors (beneath the Mat), which detect the presence or absence of a rider while the Segway HT is powered on. When a rider (weighing 100 lbs. / 45 kg or more) is aboard with feet properly positioned on the Platform, these Rider Detect sensors are depressed, and allow the Segway HT to operate normally in Balance Mode. If fewer than three Rider Detect sensors are depressed while riding, the Segway HT will reduce the top speed limit while moving forward, regardless of the Key used. If the Segway HT is in Balance Mode, but none of the Rider Detect sensors are depressed, and the Segway HT is moved too quickly, the Segway HT will give the Stick Shake Warning after moving some distance, and will switch to Power Assist Mode. This is intended to prevent a riderless Segway HT from traveling on its own. You should never let go of your Segway HT while it is in Balance Mode.

You should never place anything on the Platform. Doing so could defeat this safety feature and allow the Segway HT to travel on its own, and run into a person or property and cause injury or damage. With an i or p Series model, you *can* move a riderless Segway HT in Balance Mode an indefinite distance. To avoid getting the Stick Shake Warning, the Segway HT must be moved VERY slowly. If you move the Segway HT slowly enough, the system is able to assess that even though the Segway HT is moving in Balance Mode with no rider aboard, it is being controlled. Thus, no warning is triggered. This function makes it easier for some people to pull the Segway HT upstairs, or guide it down. Practice this technique on stairs with the participants, to show the possibility of the wheels losing traction and spinning.

## Rider Detection Demonstration – i and p Series

**Demonstrate** Rider Detection with an i or p Series Segway HT:

1. Put the Segway HT into Balance Mode.
2. Do not step on.
3. Roll the Segway HT forward a few feet at normal walking speed– until you hear and feel the Stick Shake Warning.
4. Continue a few more until the Segway HT switches to Power Assist Mode.
5. Show participants the Power Assist Mode display, so they don't think the Segway HT has shut down.
6. Let the Segway HT gently fall to the ground while guiding it.
7. Put the Segway HT into Balance Mode again.
8. Do not step on.
9. Move the Segway HT very slowly to show the speed at which it will NOT give the Stick Shake Warning.
10. Show the proper way to use riderless Balance Mode to pull the Segway HT up stairs or guide it down stairs.

**Show** the participants that there are three ways to stop the Segway HT from giving the Stick Shake Warning prior to the Segway HT switching to Power Assist Mode:

1. Roll the Segway HT back to the initial place where the Rider Detect Sensors were disengaged.
2. Tap the Mode Button to put the Segway HT into Power Assist Mode
3. Tap a Rider Detect Sensor with your foot, to re-enable Balance Mode. (Not a preferred method.)

**Emphasize** that the ability of the Segway HT to detect the presence or absence of a rider is a safety feature designed to stop the Segway HT from forward motion with no rider on the Platform.

**Direct** each participant to experience this behavior by moving the Segway HT forward she feels the Stick Shake Warning, and sees the Segway HT transition to Power Assist Mode.

**Instruct** the each participant to put the Segway HT into Balance Mode, and move it forward until the Segway HT gives the Stick Shake Warning feet. Ask participants to practice the two preferred methods to stop the Segway HT from stick shaking.

**Explain** the theory behind this behavior: The Segway HT must correctly assess when a rider is on the Segway HT in order to make a decision about whether to keep the Segway HT dynamically balancing. Being wrong in either case is undesirable because:

- **If the rider is on the Segway HT**, the Segway HT should remain dynamically balancing (because you need to remain upright).
- **If the rider is off the Segway HT**, the Segway HT should not remain dynamically balancing when the Segway HT moves, because there is no reason for it to stay upright and it could continue to move forward into a crowd or into the street.

## Rider Detection Demonstration – e Series

You can show the participants Rider Detection behavior with an e Series model, however, the e Series will not continue to move forward like the i and p Series models because of the E-Stand feature. The Handlebar will remain relatively stationary, and the wheels will pivot forward or backward until the Segway HT transitions to Power Assist Mode.

---

**Note:** If the participant experiences Stick Shake Warning with an e Series Segway HT, while placing it into E-Stand, he should **NOT** grab the Handlebar and attempt to pull or push the Segway HT. This activity often results in accidentally altering the center of gravity. The Segway HT will respond by accelerating forward or backward to regain balance. The Segway HT may move toward or away from the user, which could result in injury or damage. The Segway HT may continue to move, exceeding the distance limits or pitch range and will then transition to Power Assist Mode. If the participant experiences the situation described above, s/he should step away from the Segway HT without further touching it, or gently assist the Segway HT to find its balance point. The rider can do this by standing to the side of the Segway HT gently placing her hand against the front of the side cargo bags and slow the rocking down. The rider should not attempt to stop the Segway HT from moving completely.

---

## Safety Shutdown

If the Segway HT detects a fault in any of its redundant subsystems, the Segway HT notifies you by automatically reducing its speed, shaking its Handlebar, making growling and beeping noises, and flashing red in the Display. This is called Safety Shutdown.

If a Safety Shutdown occurs:

- > Immediately come to a controlled stop.
- > Carefully step off one foot at a time.
- > Do not resume use of your Segway HT until the fault condition is cleared.

## Empty Battery Condition

One of the conditions that can result in a Safety Shutdown is an empty battery condition. The Segway HT will notify you of a pending empty battery condition prior to initiating Safety Shutdown. A red unhappy face icon will appear in the Display, the Segway HT's speed will be limited, and the Segway HT will beep. You should come to a controlled stop and safely step off of the Segway HT prior to commencement of the Safety Shutdown. The red unhappy face icon will be shown in the Display.

Never restart and ride your Segway HT after it has indicated an empty battery condition or performed a low battery Safety Shutdown. The Segway HT may not have enough power to keep you balanced, especially if you demand a lot of power at once. If you restart and continue riding, you risk falling. Also, you may damage your Battery Packs, resulting in reduced Battery Pack life and capacity.

## Safety Shutdown while entering or leaving a building

Theft detection systems may interfere with Segway HT operation. Many libraries, retail stores, and other buildings use theft detection systems to detect protected items as they enter and exit a building. These systems are usually situated at the building entrances and exits so that patrons must pass through on their way in and out. These systems may not always be visible. Some theft detection systems have caused the Segway HT (in Balance Mode) to perform a Safety Shutdown.

1. Step off at least 5 feet (1.5 meters) away from theft detection systems and proceed through the theft detection system in Power Assist Mode or with the Segway HT powered off.
2. Once at least 5 feet (1.5 meters) away from the detectors, riders may return to Balance Mode and step on.

**Demonstrate** the Safety Shutdown using the fault insertion key. Coach the rider to:

- > Bend knees, use a light grip
- > Be prepared for a dynamic/brisk tilt backward on the Platform
- > Don't try to respond or compensate, simply ride it out

**Emphasize:** This exercise is to **expose** the rider to what a Safety Shutdown

**Instructor:** Hold the Segway HT by the Control Shaft when the unit slows.

**Explain:** “I will be alongside you. I will insert the fault insertion Key, simulating a disconnect between the Control Shaft Cords and the Controller Boards. I want you to remain on the Segway HT until it is stopped, then step down off the Platform with both feet. I will be holding the Segway HT when it slows and comes to a stop. You have approximately 10 seconds to come to a controlled stop and safely step off during a Safety Shutdown, so don’t panic or rush, but be prepared to step off as soon as you safely can.

**Make sure** the rider is wearing a helmet, and that you are holding the Control Shaft securely during the deceleration and stick shakes. Instructor should be prepared to receive all the weight of the rider.

---

**Important:** Emphasize that the rider must step down, and remove BOTH feet from the Platform. Otherwise, she is still giving input into the system, and the system will respond to any requests to stay balancing.

---

---

**Important:** If the aft pitch angle exceeds 20° backward, the Segway HT will shut down rather than accelerating in reverse. This is an important safety feature. Ensure the rider does not lean over the Handlebar as the Segway HT is limiting speed.

---

Repeat the experience for each rider.

**Say:** “Never ride through a Safety Shutdown. Recognize the alerts and signals, slow down and stop, then safely step off.”

## Torque and Traction

If the Segway HT encounters a condition in which it can no longer perform in an acceptable manner, it will disable power. This is the case if pitch or roll parameters are exceeded or if the wheels spin because of traction loss.

**Demonstrate** roll or pitch parameters being exceeded, depending on the Segway HT model you have.

**i or p Series:** Stand to the side and lean the Segway HT sideways without allowing the Platform to tilt forward or backward. Lean it over until it shuts down.

**e Series:** From E-Stand, push the Segway HT backward. As you continue to push the Segway HT backward, the wheels will move and eventually, the pitch parameter will be exceeded. The Segway HT will transition to Power Assist Mode and torque will no longer be delivered to the wheels.

The Segway HT tires must grip the ground for the machine to stay upright. If the tires cannot generate a reaction force, the Segway HT cannot stabilize itself. The system assesses how fast the wheel is accelerating. If the wheel accelerates too fast, then the Segway HT concludes that it cannot balance effectively and temporarily nullifies the motor torque to allow the wheel to regain traction. Once the wheel has slowed down, the torque is reengaged.

## Avoid slippery surfaces

A person slips when stepping on ice or other slippery surfaces because the person loses traction—the person’s shoe does not grip the surface. The Segway HT can slip in the same way. If a tire loses traction, then the Segway HT cannot move to stay upright and the rider could fall. To be safe, you must avoid slippery surfaces, such as ice, wet floors, wet grass, or any other surface that you might slip on if you were running. Also, remember that wet, soapy, and oily tires can lose traction and slip on any surface, so use extreme caution.

## Avoid loose objects and materials

A person can also slip by stepping on a branch, cord, or other object that rolls under foot or by stepping on loose materials like small stones. The Segway HT can slip in the same way. To be safe, you must avoid riding over loose objects or materials.

## Avoid steep slopes

A person is more likely to slip walking up or down a steep slope because he needs more traction. In the same way, if you ride your Segway HT up or down a steep slope, you are more likely to lose traction and fall. To be safe, you should avoid riding up or down steep slopes.

The Segway HT will disable torque to the wheels if the sensor data indicate that the Segway HT is on the edge of its operating limits:

- > Excessive pitch or roll angle
- > Failed Speed Limiter (system unable to regulate speed)

## Effect of Tire Pressure

The tires on the Segway HT serve two primary functions:

- > Suspension
- > Traction

Dropping the tire pressure will soften the ride and increase traction while reducing range. The appropriate pressure is determined by the payload weight and the operating environment. Optimum tire pressure is 15 psi (103 kPa) for i and e Series models; and for the p Series model it is 22 psi (152 kPa).

For an i or e Series with the maximum payload, the tire air pressure can be increased to 22 psi (152 kPa) depending on the surface conditions, to avoid flattening out the tires under the payload weight.

## Summary

1. What have you learned since this morning? Name a few specifics.

2. Why would the Segway HT speed limit you?

Review the following:

- > The Key used to power on
- > Steepness of a hill
- > Bumpy terrain
- > Battery Pack charge
- > The first few seconds after power on
- > Foot pressure on the Platform (number of Rider Detect Sensors depressed)
- > Battery Pack temperature

3. How do you know when the Segway HT is speed limiting you?

- > Handlebar push into torso
- > Platform tilts aft
- > Segway HT feels resistant to increased speed

4. What is the appropriate reaction?

Slow down.

**5. When will the Segway HT give a Stick Shake Warning?**

- > Riding aggressively, accelerating or stopping abruptly.
- > Riding against the Handlebar.
- > Riding on rough terrain or steep slopes.
- > Riding against an obstruction.
- > Riding backward.
- > During Safety Shutdown.
- > Moving a Segway HT with no rider on the Platform while in Balance Mode.
- > Stepping onto a Segway HT Platform while in Power Assist Mode.

**6. Describe Rider Detection.**

The Segway HT detects the absence or presence of a rider on the Platform by reading the pressure on the Rider Detect Sensors.

**7. What safety mechanism does the Rider Detection perform?**

It attempts to stop the Segway HT from moving with no rider on. On an i or p Series, this takes much longer if released at speed, than from a stationary position. On an e Series, this function is overridden by the E-Stand function.

**8. When will the Segway HT perform a Safety Shutdown?**

When there is a critical component or system malfunction in the:

- Controller Board
- > Motor
- > Battery Pack
- > Balance Sensor Assembly (BSA)
- > Handlebar systems
- > Control Shaft cord
- > Excessive rate sensor error
- > Systems communication failure

**9. What does the Segway HT do during a Safety Shutdown?**

If the Segway HT detects a fault in any of its redundant subsystems, the Segway HT notifies you by automatically reducing its speed, shaking its Handlebar, making growling and beeping noises, and flashing red in the Display.

**10. When might the Segway HT stop balancing, even with a person on the Platform, prior to the end of the 10-second window?**

When pitch limit is exceeded (usually backward, 20°)

## > Session 5 Agility Track – Riding Skills

**Who.** Entire group

**What.** Negotiate terrain features on agility track

**Where.** Agility track

**Method.** Observation and experiential learning—watching and riding the Segway HT.

### Timing

**Total Time**

**45 min**

### Introduction

In this session, the riders will practice their riding techniques and improve their understanding of the Segway HT's capabilities. They will be coached to exercise etiquette on the agility track while interacting with other riders.

### Objectives

**Upon completion of this session the rider should be able to:**

- > Describe the Segway HT's capabilities and limitations.
- > Ride around and over a variety of terrain features that simulate the real world.
- > Demonstrate smooth operation and speed control around and over terrain features.
- > Explain how uneven terrain affects lateral stability.

### Topics

**The following topics will be covered in this session:**

- > Before You Ride...
- > Agility track
- > Summary

### Before You Ride

**Exercise Segway Etiquette.** The Segway HT has been designed to be compatible with pedestrian environments. You will have the ability to move seamlessly in these environments, possibly with more cargo and speed than those around you. Your judgment and courteous behavior will help you earn your place in these environments. You have a responsibility to those around you.

- > Take account of those around you who may be less agile.
- > Move predictably – avoid sudden movements.
- > Use a speed that is compatible with those around you.
- > Slow down for pedestrians – pass slowly and courteously.
- > Slow down for corners and cross paths.

**Gain an understanding of the Segway HT's Capabilities.** Imagine the speedometer in your car. Just because you see a dial with 120 mph speed capability, doesn't mean that you should drive that speed or that you would be capable of doing it responsibly.

Normally, participants are at the **Conscious Incompetence** stage, "I know what I don't know." For example, I know that I don't know the Segway HT's capabilities and limitations. I know that I don't know how I will handle a slippery surface. I know I don't know how the Segway HT will perform on a steep incline."

## Agility Track

The Segway agility track is designed to optimize the rider's effective use of the Segway HT in real world environments. The rider will practice steering control, lateral stability, speed control and absorbing shock over a variety of surfaces. In this session, you will experience:

### Basic Rider Skills

Demonstrate the proper form over each terrain feature, then have each rider practice while the instructor stands by to spot, coach and assist.

- > **Slalom**
- > Ask rider to incrementally increase speed as they master the technique
- > Keep knees bent/loose grip on Handlebar
- > Instruct the rider to lean into turns
- > **Bumpy terrain**
- > Approach squarely
- > Bend knees to absorb shock
- > Use light grip
- > Don't twist the Steering Grip
- > Instructor should closely spot the rider
- > **Ascending and descending a 3" (7cm) ramp/slope**
- > Approach the slope squarely
- > Be prepared to increase forward lean to ride up incline, but do NOT push on Handlebar
- > Be prepared to increase backward lean to ride down incline
- > Instructor should closely spot the rider on the initial attempts
- > **Ascending and descending a 3" (7cm) curb**
  - > To ascend the 3" (7cm) curb, step off the Segway HT and use Power Assist Mode.
  - > For an i and p Series model, you can drive to the curb, leave the Segway HT in Balance Mode, and pull it over the curb from the front of the Segway HT, but be aware that if you exceed speed or distance, the Segway HT will give the Stick Shake Warning and/or transition to Power Assist Mode.
  - > For an e Series model, you should use Power Assist Mode. Do not leave an e Series Segway HT in Balance Mode and move it, because it will attempt to remain stationary in E-Stand when no Rider Detect Sensors depressed. If moved too far, it will give the Stick Shake Warning and/or transition to Power Assist Mode.
  - > To descend the 3" curb, ride off squarely using the step method for an i or p Series model, or drop down squarely while riding an e Series model. (The step method involves transferring one foot to the ground, transferring weight onto that foot momentarily as you leave the curb, then replacing your foot onto the Platform.)
  - > Bend knees and absorb the shock of landing.
  - > Keep a light grip on Handlebar. Do NOT push forward.
  - > Slowly ride off the curb,
  - > Don't back into the curb once you have dropped down.
  - > Instructor should closely spot the rider
- > **Descending and riding across a 3" (7cm) curb, angled**
  - > Ride off at an angle.
  - > Be prepared for lateral instability.
  - > Bend knees and absorb the shock of landing.
  - > Slowly ride off curb on initial attempt.
  - > Instructor should closely spot the rider on the initial attempts.
  - > Approach the ramp squarely and ride up ramp with only one wheel on, the other on flat ground.
  - > Transfer weight to lower foot.
  - > Lean into the slope

- > Be aware of ground clearance.

## Doors

Practice riding through doorways in order to familiarize yourself with your new height and width.

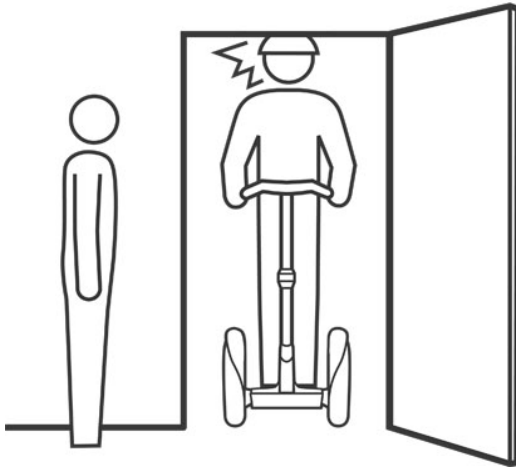

Approach doorways carefully, and remember that you are approximately 8" taller and slightly wider than when you are walking.

- > Bend your knees and body to avoid hitting the top of the doorframe and to absorb the shock of any transition between the two rooms.
- > Look ahead and anticipate any drop-offs on the other side of the door. Step off and use Power Assist Mode in these instances.
- > **Keep wheels clear** of the sides of the doorway. If your wheel catches on either side, step off, change to Power Assist Mode, and maneuver the Segway HT away from doorway before stepping back on.

## Stairs

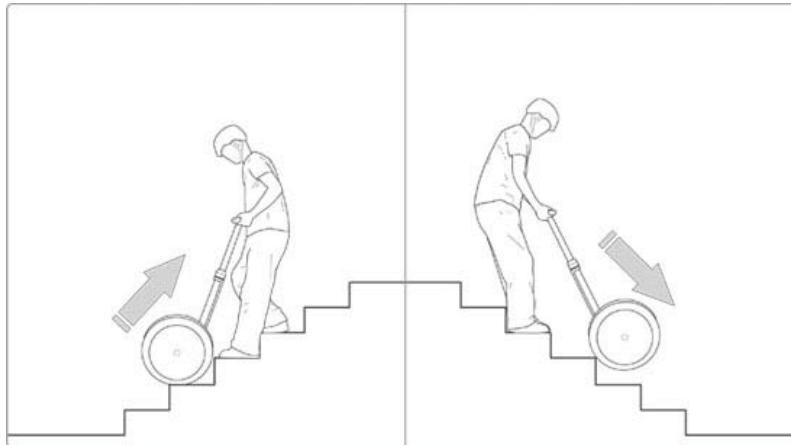

Use Power Assist Mode to go up and down stairs.

- > Stand to the side the first few times you use Power Assist Mode, to get the feel of the Steering Grip.
- > Always have the Segway HT's weight below you, so if you stumble, the Segway HT will not fall onto you.
- > Keep the Segway HT's wheels square to the stairs.
- > Take your time.

## Traction Loss

The Segway HT needs traction to operate. Slippery surfaces reduce traction capability of the Segway HT's tires in the same way they reduce traction capability in people. If you are unable to avoid the slippery surface, step off and negotiate in Power Assist Mode. Do not ride over any slippery surface.

### Guided experience over a dowel

---

**Note:** *The dowel exercise is for the student to experience the sensation of loss of traction. As with all exposure exercises, practicing this outside the classroom, without the appropriate instruction, is never encouraged.*

---

**Demonstrate:** Place a dowel on the floor and demonstrate pulling the i or p Series model over the dowel. To achieve the desired effect safely, you must stand to the side, and bear down on the Handlebar as you simulate a rider going over a slippery surface.

**Ask** riders to watch the tires as they spin out. Point out that traction loss can be instantaneous and dramatic.

## Optional: Outdoor Riding Skills

Depending on weather and available riding environment, the rider will experience the following terrain features and take during an outside ride.

### Narrow Sidewalk

Traverse a narrow pathway without hitting any cones. Slow down to correct alignment. Keep equal distance from each edge.

### Inclines/Declines

The Segway HT has the capability to climb and descend gentle hills.

Avoid steep slopes. A person is more likely to slip walking up or down a steep slope because he needs more traction. In the same way, if you ride your Segway HT up or down a steep slope, you are more likely to lose traction and fall. To be safe, you should avoid riding up or down steep slopes.

Lean into turns and lean uphill. When riding a Segway HT, you must lean in the same way. You are responsible for maintaining side-to-side balance by leaning uphill when riding across slopes (or whenever one wheel is higher than the other) and by leaning into turns. If you fail to actively maintain this side-to-side balance, the Segway HT will tip sideways and you, and the Segway HT could fall. This is why you must always lean into turns, avoid riding across steep slopes, and lean uphill when riding across any slope.

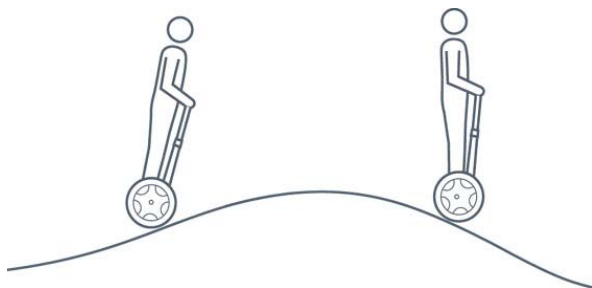

The instructor must guide the rider up and down the slope each time until she is certain participants have the correct form. Instructor should spot the rider closely.

- > Lean forward to go up, pushing on your toes rather than the pushing Handlebar.
- > Lean backward to go down, pushing on your heels, rather than pulling Handlebar.
- > Practice stopping half way up and down, to gain confidence and control.
- > Achieve a smooth ascent and descent without jolting.
- > Do not stop on the transition between the flat ground and the slope.
- > Align yourself squarely in center of ramp, not too close to either edge.
- > Come to a stop, correct alignment, and continue.
- > Approach the incline squarely.

- > Be prepared to increase forward lean to ride up incline.

## Single Wheel Terrain Features (Potholes)

**Discuss** the fact that most downtown/city riding environments have many potholes and curb cuts. These pose a challenging environment that may cause over-confident riders to ignore the potential problems.

**Illustrate** the lateral *instability* that tends to happen when you hit a pothole going at a little speed.

**Reinforce** the need to go through curb cuts squarely and with caution, and NOT to stop in a hole, and then attempt to start moving again. If you stop in a hole, to be safe, you must get off the Segway HT and pull it out of the hole onto flat ground before continuing to ride.

**Avoid single wheel terrain features.** Riding over a pothole, rock or slippery surface with one wheel may cause the Segway HT to turn suddenly. This may lead to a loss of stability. These situations can make the HT trip, just like a person.

For example, a person may trip if she unexpectedly hits an obstacle with her foot or steps into a hole or off a curb. The person leans forward, expecting to take a normal stride, but the obstacle, hole, or curb prevents her leg from moving as expected, and she trips. The Segway HT can trip in the same way. If a Segway HT wheel runs into an obstacle, wall, hole, or off a curb or step, the Segway HT might not be able to move as necessary to stay upright, and the Segway HT and rider could fall. To be safe, you must avoid riding into holes, walls, other obstacles, or into or off curbs or steps.

### If you cannot avoid single wheel terrain features, use the following guidelines:

- > Step off and use Power Assist Mode if there is any question about your ability to ride over the terrain.
- > If riding, look ahead and anticipate terrain features, keep arms, legs bent, relaxed, hands loose to avoid twisting the Steering Grip.
- > If riding, lean uphill to absorb the impact with your knees and body.

Instruct riders to:

- > Ride off obstacle squarely.
- > Be prepared for lateral instability.
- > Bend knees and absorb the shock of landing.
- > Shift weight to upper foot while coming out of the hole.
- > Slowly ride off curb.
- > Instructor should closely spot the rider on the initial attempts.

**Conduct** an open discussion on other obstacles to avoid. Encourage the group to think of things that could be dangerous to ride and should not be ridden over/under/on/through including puddles (you never know how deep they might be or what is on the bottom), fire hydrants, tree limbs, overhead street signs, tree roots, a garden hose, cabling, rebar, chain, frost heaves, loose sand, metal plates and grates, etc.

## Summary

Review your experiences.

Discuss the capabilities of the rider and the Segway HT.

Explain how the environment affects your capabilities.

Discuss characteristics of Segway etiquette.

## > Session 6 Maintenance and Service

<b>Who.</b>	Entire group
<b>What.</b>	Perform customer-serviceable parts procedures on the Segway HT. Make sure you have tools (see “Required Tools” on page 74) and supplies:
<b>Where.</b>	Classroom/floor space
<b>Method.</b>	Interpretation of written procedures, observation and experiential learning—watching and performing maintenance procedures on the Segway HT

### Timing

Summary and Q&A  
**Total Time**

5 min  
**15 min**

## Introduction

The Segway HT has been designed for low maintenance. There are, however, several maintenance procedures with which all operators should be familiar. In this session, we will talk about tire pressure, Battery Pack charging, and cleaning. Additionally we will examine a listing of user-serviceable parts along with the procedures for replacing them.

## Objectives

**Upon completion of this session the rider should be able to:**

- > Perform routine user adjustments and maintenance
- > Safely handle and charge the Battery Packs
- > Replace common wear items
- > Securely package Segway HT for shipment back to the factory

## Topics

**The following topics will be covered in this session:**

- > Segway HT Maintenance
- > Replacing User-serviceable Parts
- > Packing Your Segway HT for Shipment
- > Summary

## Segway HT Maintenance

Segway Customer Operations can answer your questions about your Segway HT via the Web, email, or phone. If you have a question about parts or replacement procedures, please contact us using the information below:

### Hours of Support Operation

8:00 am - 8:00 pm Eastern Time, Monday - Friday

(Except Segway observed holidays)

Phone: 1-866-4SEGWAY (1-866-473-4929)

Fax: (603) 222-6001

Email: [technicalsupport@segway.com](mailto:technicalsupport@segway.com)

Review the Limited Warranty for specific information. You will receive the Limited Warranty document with your Segway HT.

**Procedures for replacing or installing User-serviceable parts include:**

- > Replacing the Battery Packs
- > Replacing a Tire/Wheel Assembly
- > Replacing the Mat
- > Securing or Replacing the Front Trim
- > Replacing the Fender
- > Replacing a Parking Stand (i Series only)
- > Replacing the Handlebar/Control Shaft Assembly
- > Replacing the Fixed Grip
- > Replacing the Steering Grip
- > Replacing the Charge Port Cover
- > Replacing the Control Shaft Clamp
- > Installing an Upper Frame and Bag Cargo Structure

**Cleaning and Exposure to Water**

All parts of the Segway HT can be cleaned with **soap and water** and a soft cloth. the Segway HT is designed to withstand brief exposure to water, but not submersion. Avoid submerging the Battery Packs or Platform. Avoid getting water in the Charge Port. Always close the Charge Port Cover after charging. Do not use a high-pressure hose. Never clean the Mat or tires with any specialized cleaners (such as Armor All®). These products may reduce traction.

**If Your Mat Sticks to the HT Platform**

If pressing the Mode Button does not cause the Segway HT to power down or change into Power Assist Mode, your Segway HT Mat may be sticking to the riding Platform. If this happens, lift the Mat to release it, while being careful to hold onto your Segway HT, and not to move it forward or backward. If the problem persists, call Segway Customer Operations at 1-866-4SEGWAY.

**Tire Pressure**

Recommended tire air pressure for each model is as follows:

<b>Model</b>	<b>i Series</b>	<b>p Series</b>	<b>e Series</b>
<i>Optimum Pressure</i>	15 psi (103 kPa)	22 psi (152 kPa)	15 psi (103 kPa)

Changing tire pressure will affect traction, shock absorption and range in the following ways:

<b>Tire Pressure</b>	<b>Traction</b>	<b>Shock Absorption</b>	<b>Range</b>
<i>Lower Pressure</i>	↑	↑	↓
<i>Higher Pressure</i>	↓	↓	↑

**Batteries**

Two rechargeable Battery Packs power your Segway HT. Take some time to read and understand these guidelines for your own safety and to extend the life of the Battery Packs.

Segway HT NiMH Battery Packs will discharge (i.e. power the Segway HT) until they reach 135°F (57°C). The Battery Packs will generally be significantly warmer than ambient temperatures due to the heating that occurs as electricity passes through the Battery Packs.

At 135°F (57°C), the Speed Limiter will be activated to reduce any internal heating caused by high discharge currents. The Display face will also change from a green smiling face to a green straight face.

At 140°F Battery Pack temperature (60°C), the Segway HT will perform a Safety Shutdown. This temperature can potentially damage the Battery Packs. The Segway HT can be restarted and will operate normally when the Battery Packs have cooled down.

## Safety Guidelines

**WARNING!** Unplug and disconnect your Segway HT from AC power before removing or installing Battery Packs. It is hazardous to work on any part of your Segway HT when it is plugged into AC power. You risk serious bodily injury from electric shock as well as damage to your Segway HT.

The cells within the Battery Packs contain toxic substances. Do not attempt to open Battery Packs. Do not insert any object into the Battery Packs or use any device to pry at the Battery Pack casing. If you insert an object into any of the Battery Packs' ports or openings you could suffer electric shock, injury, burns, or cause a fire. Attempting to open the Battery Pack casing will damage the casing and could release toxic and harmful substances.

Use care when handling the Battery Packs. If you are transporting your Segway HT, be sure to protect the Battery Packs to avoid damage during shipment. If the casing or gaskets of a Battery Pack should break open, leak any substance, become excessively hot, or if you detect an unusual odor, do not use the Battery Pack. Do not handle a damaged or leaking Battery Pack unless you are wearing protective rubber gloves. Dispose of the rubber gloves and damaged Battery Pack properly in accordance with regulations governing disposal of toxic materials.

Keep Battery Packs out of reach of children and pets. Ingesting toxic substances and exposure to battery voltage could result in death or serious injury.

## Charging

Heat is produced when charging NiMH Battery Packs. It is very important to the life and performance of the Battery Packs that they remain in the appropriate temperature range during charging.

If you attempt to charge the Battery Packs, and the Battery Pack temperature is below 32°F (0°C) or above 40°C (104°F), the Battery Packs will not “quick charge” (solid green LEDs/second stage of charging). The charge supply will continue to blink, indicating a slow or trickle charge, until the temperature stabilizes inside the range. This is to protect the Battery Packs from damage.

Even if you leave the Segway HT plugged in for an extended period of time (beyond six hours), and return to see the LEDs blinking, the Battery Packs may have trickle-charged the entire time; which will have put only a small amount of energy into the Battery Pack. There may not be enough power to ride safely. You should unplug the Segway HT, wait for the Batteries to stabilize within the recommended temperature parameters, and then begin charging.

To maximize battery life and performance, follow this procedure to charge your new Segway HT. Battery Packs before the first use and after the first five uses:

1. As soon as possible and before your first use, charge the Battery Packs for at least 12 hours. Charging is best performed at room temperature.
2. Limit the duration of the first five uses of your Segway HT so that you do not discharge the Battery Packs below the charge level illustrated at right:
3. After each of your first five uses, charge the Battery Packs for at least eight hours.



In order to maintain the best performance from your Segway HT Battery Packs, charge your Battery Packs for at least 12 hours once a month, or once every 12 hours of operation— whichever comes first.

Even if you do not intend to immediately use your new Segway HT, you should still charge the Battery Packs for at least 12 hours as soon as possible. You should always plug your Segway HT into AC power when it is not in use. Otherwise, the Battery Packs could fully discharge over time, causing them permanent damage. You do not need to worry about overcharging.

Do not store your Segway HT or Battery Packs for more than one month without charging. This could cause permanent damage to the Battery Packs.

### To Charge the Segway HT Battery Packs

1. Make sure the Charge Port is dry. Do not insert the plug if it is wet.
2. Plug one end of the Power Cord (provided with your Segway HT) into the Charge Port in the Control Shaft Base.
3. Plug the other end of the Power Cord into a grounded AC outlet (100 V to 240 V; 50 Hz to 60 Hz). The Power Cord should be properly grounded for charging.

### Charging Indicators

The Control Shaft Base has two LED (Light Emitting Diode) charging indicators located below the Charge Port.



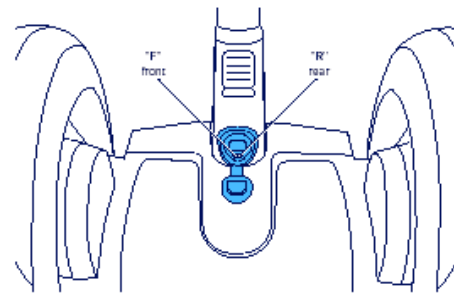

The left charging indicator corresponds to the front Battery Pack, the right to the rear Battery Pack. They are marked with an "F" and "R," respectively. The charging indicators provide independent information regarding whether each Battery Pack is charging. Any time the LED green light is on, the respective Battery Pack is receiving a pulse of current. Slow pulse rates are slow charging rates, faster rates denote faster charging, and solid green is the maximum charge rate.



### Charging Process

There are four stages in the charging process:

1. Immediately after the Segway HT is plugged in, the Battery Packs perform a test to determine if it is appropriate to charge at the maximum charge rate. While this test is occurring, the Battery Packs charge slowly at a trickle rate. The charging indicator pulses green every few seconds, giving the Battery Pack short pulses of current.
2. After about two minutes (longer if the Battery Packs are very warm, cold, or completely discharged), the Battery Packs will begin charging at the fast rate, with the charging indicator glowing solid green.
3. The Battery Pack electronics will monitor the Battery Pack voltage and temperature to determine when it is full and will then start pulsing at a rapid rate. This rapid pulsing rate will continue for approximately three hours while a cell balancing process is completed to distribute the energy throughout all the cells in the Battery Packs.
4. At the end of the cell balancing process, the pulse rate will become slow and will continue at the slow rate until the Segway HT is unplugged.

Charge Indicator	Battery Pack State
 Slow Pulse	Initial test to assess Battery Pack status and amount of charging needed.
 Solid LED	Fast charge, when approximately 90% of charging takes place.
 Fast Pulse	Cell balancing process, during which the cells are topped off equally.
 Slow Pulse	Trickle charge to keep Battery Packs fully charged.

**Charging Failures**

If a failure is detected during charging, all charging will stop. Depending on the nature of the failure, a solid red charging indicator light will be displayed or the charging indicator will be off.

If either or both charging indicators are off or red, do this:

- > If the charging indicators are off (no illumination), check to make sure that AC power is present.
- > If AC power is present and the charging indicators are either red or off, disconnect from AC power, then remove and reseat the Battery Pack(s), following the instructions on page 75.
- > If this does not resolve the problem, contact Segway Customer Operations at 1-866-4SEGWAY (1-866-473-4929).

**Before Each Ride—Remember to Close the Charge Port Cover**

Close the Charge Port Cover except when you are charging the Segway HT. Closing the Charge Port Cover will prevent water, dirt, dust, and other contaminants from entering through the Charge Port and causing damage to your Segway HT.

**Battery Charge Level Display**

The dashed ring around the perimeter of the Display indicates the battery charge level. The following series of displays illustrates a gradually depleting battery charge while in Balance Mode:



Full charge

Low charge

This series of displays illustrates the same battery charge levels while in Power Assist Mode:



Full charge

Low charge

The Segway HT will display intermediate battery charge levels using flashing segments (e.g., a battery at approximately 90 percent will display a flashing top bar).

If the battery charge level is very low, the Segway HT will notify you of a pending empty battery condition prior to initiating Safety Shutdown (see page 58).

Do not ride your Segway HT if there is inadequate charge in the Battery Packs (indicated by the red unhappy face icon in the Display and no segments around the perimeter). Carefully monitor your Display and be prepared to step off if your battery charge becomes completely depleted.

The battery charge level display shows the relative charge level. No battery gauge is accurate enough to predict exactly when your battery charge will be totally depleted. It is best to keep track of your battery charge level and recharge whenever possible.

In certain situations, such as riding uphill, the battery charge level display may temporarily drop because you are drawing heavily on the Battery Packs. The battery charge level display should return to the actual charge level once you return to level ground and reduce the load on the Battery Packs.

### **Surface Charge**

Surface charge is a common side effect that results in inaccurate battery charge level information when you have not fully charged batteries.

Whenever you do not fully charge the Segway HT's Battery Packs (i.e., complete the cell balancing process, see page 70), or when you are not drawing any power for a period of time, there is a possibility of surface charge affecting the battery charge level display. This could cause the display to falsely show a greater charge level. After you power on, check the battery charge level display, then ride for at least three or four minutes and check the battery charge level display again. If the battery charge level display shows rapid charge depletion during these three or four minutes, you should conclude that the Battery Packs had only a surface charge. In that case, plug the Segway HT back in and recharge.

### **Battery Pack Temperature Parameters**

The Battery Packs will generally be significantly warmer than the air temperature due to heating that occurs as electricity is delivered from them. If the Battery Packs on your Segway HT become too hot or too cold while riding, the Segway HT may reduce performance (Display icon with straight mouth, Speed Limiter and possibly Stick Shake Warning) or perform Safety Shutdown. Ease up. If performance does not return to normal, stop riding and allow your Battery Packs to warm or cool to within the recommended operating temperature range.

Your Battery Packs should be as close as possible to the optimum charging temperature range prior to and during charging (see page 11). If your Battery Packs are too hot or too cold, the charging indicator will continue to blink, indicating a slow or trickle charge, until the battery temperature is within or near the optimum charging temperature range. Once stabilized within this range, the fast charge will begin and the charging indicator will be solid green.

If the charging indicator lights remain blinking throughout the entire time that the Segway HT is plugged in, then the Battery Packs have trickle charged the entire time. This will provide only a small amount of energy into the Battery Packs.

### **If you are concerned that the Battery Packs may be too cold or overheated during charging:**

- > Check the charging indicators to make sure they show solid green, indicating fast charge.
- > If the charging indicators do not show solid green within 15 minutes after the Segway HT is plugged in, move the Segway HT to a location within or near the optimum charging temperature range.
- > After the Battery Packs are within the proper temperature range, reconnect the Power Cord.

If the charging indicators still do not show solid green within 15 minutes, contact Segway Customer Operations at [www.segway.com](http://www.segway.com) or call 1-866-4SEGWAY (1-866-473-4929).

### **In Hot Conditions, You Can Improve Charging By:**

- > Moving the Segway HT or off board charging unit out of the sun, or off of hot asphalt. (Into an air-conditioned environment is best!)
- > Placing a fan near the Segway HT or off board charging unit to blow air over the batteries.

## Regenerative Braking

The Segway HT has a regenerative braking system that charges the Battery Packs when descending a hill or slowing down.

## Replacing Battery Packs

Battery Packs should last the equivalent of 300 to 500 full charges. As your Battery Packs near the end of their useful life, you will notice that they need more frequent charging and that your Segway HT has reduced range. You may order replacement Battery Packs by contacting Segway Customer Operations at [www.segway.com](http://www.segway.com) or calling 1-866-4SEGWAY (1-866-473-4929).

### Replace Battery Packs in Pairs

Whenever you replace a Battery Pack, consider replacing both Battery Packs. Replacing only one Battery Pack will not necessarily increase the performance or range of your Segway HT. This is because the Segway HT is designed to operate at the level allowed by the lower-energy Battery Pack. This is a safety feature.

## Replacing User-Serviceable Parts

If a part breaks or needs replacement, contact Segway Customer Operations. Certain parts are user-serviceable and Segway provides those replacement parts with installation instructions. Use only Segway-provided parts and fasteners.

**WARNING!** Always shut down your Segway HT and unplug the Power Cord before performing any maintenance or installing any part or accessory.

### Disclaimer; Updates; Warnings.

These parts replacement instructions and the information contained in these parts replacement instructions are provided "as is" without any representation or warranty, express or implied, of any kind, including, but not limited to, warranties of merchantability, noninfringement, or fitness for any particular purpose.

The only warranties applicable to Segway replacement parts are stated on the "Segway™ Human Transporter Replacement Parts Limited Warranty" delivered with the replacement part. Segway makes no other express or implied warranty.

Segway may update these parts replacement instructions. Segway will post notices of parts replacement instructions updates at [www.segway.com](http://www.segway.com). Before using these parts replacement instructions, the user must check for such updates.

If a user is in doubt as to how to proceed with any replacement of a part on a Segway product, the user should contact Segway Customer Support at [www.segway.com](http://www.segway.com) or 1-866-4SEGWAY (1-866-473-4929) with any questions.

Each procedure in these instructions for replacement of a part includes specific warnings, cautions, and instructions applicable to that specific procedure. Users must follow those specific warnings, cautions, and instructions.

Improperly replacing a part on a Segway product exposes the person replacing the part (and subsequent users of the Segway product) to risk of injury and also risks causing damage to the Segway product. Users must comply with all warnings, cautions, and instructions contained in these Parts Replacement Instructions and that may be issued by Segway as updates.

Use only Segway provided replacement parts and fasteners when replacing parts on Segway products. If any user discovers any error in these Parts Replacement Instructions, the user should notify Segway Customer Support at [www.segway.com](http://www.segway.com) or 1-866-4SEGWAY (1-866-473-4929).

## Required Tools

You will need the following tools:

- > Hex wrenches, sizes 2.5, 3, 4 and 5MM
- > Torque wrench with parameters where 50 Newton Meters (N-m) falls near the middle of the range
- > 16MM deep socket
- > T-15 or T-20 six lobed wrench (depending on Segway HT vintage)
- > Flathead screwdriver
- > Air pressure gauge
- > Tire pump
- > Plastic or rubber mallet
- > Alcohol wipes
- > Tweezers

## HT Fastener Guidelines

1. Use only Segway-provided fasteners.
2. Do not reuse any fastener except for the screws used to attach the Battery Packs, Control Shaft clamp bolt, and wheel nuts. Instead, when any other fastener is removed, replace the fastener with a new Segway-provided fastener.
3. Before using a fastener, make certain the fastener is the correct size and type.
4. Do not attempt to repair any stripped or damaged screw hole. Instead, replace the part.
5. Insert fasteners slowly and carefully. Do not cross-thread or over-tighten fasteners. Tighten only to the prescribed torque. If a fastener is cross-threaded, call Segway Customer Operations at 1-866-4SEGWAY.

## Replacing the Battery Packs

**Tools Required:** 3.0mm hex wrench, torque wrench

### Before you begin:

**WARNING!** Do not attempt to open Battery Packs. The cells within the Battery Packs contain toxic substances. If the casing of a Battery Pack is broken or if a Battery Pack emits an unusual odor or excessive heat or leaks any substance, do not use the Battery Pack. Do not handle a damaged or leaking Battery Pack unless you are wearing protective rubber gloves. Dispose of rubber gloves and damaged Battery Pack properly in accordance with regulations governing disposal of toxic materials.

Use care when handling Battery Packs. If you are transporting your Segway HT, be sure to protect the Battery Packs to avoid damage during shipment.

Inspect Battery Pack gaskets (foam rubber material surrounding the connector). Gaskets need to be in place and in good condition.

Keep Battery Packs out of reach of children and pets.

Always shut down your Segway HT and unplug the power cord before performing any maintenance or installing any part or accessory.

Read and follow the warning label on the Battery Pack.

Follow these instructions carefully. Failure to follow these instructions carefully could damage your Segway HT and render it unsafe to use.

Do not mix Battery Pack types. The Segway HT uses 2 NiCd or 2 NiMH Battery Packs. The Segway HT operates at the performance level allowed by the lesser battery. Whenever you replace a Battery Pack, you should consider replacing both Battery Packs.

Contact the Rechargeable Battery Recycling Corporation (RBRC) for proper recycling procedures. Telephone 1-800-822-8837 or visit [www.rbrc.org](http://www.rbrc.org).

### Directions:

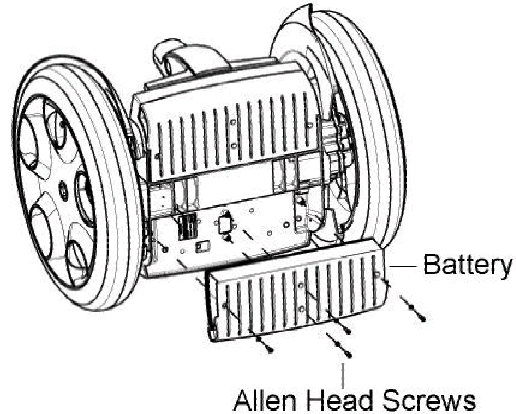

Tip the Segway HT to expose the bottom of the chassis and

1. Use 3mm hex wrench to remove screws of the Battery Pack(s) you wish to replace (4 per Battery Pack).
2. Pull the Battery Packs straight off of the chassis.
3. Seat the new Battery Packs on the chassis with the curved edge facing outside of chassis.
4. Thread in the four socket screws and torque to 0.5 N-m. (Do not over-tighten.)

In order to maximize battery life and performance, you must follow the procedure for charging and conditioning new Segway HT Battery Packs, beginning on page 68.

## Replacing a Tire/Wheel Assembly

**Tools Required:** 16mm socket wrench, rubber or plastic mallet, torque wrench, alcohol wipes, air pressure gauge, tire pump

### Before you begin:

- > Make sure Segway HT is shut down and not plugged into AC.
- > Place a carpet or pad on the floor, to protect the wheel when you tip the Segway HT onto its side.
- > Tip the Segway HT onto its side so that the Tire/Wheel Assembly to be replaced faces up

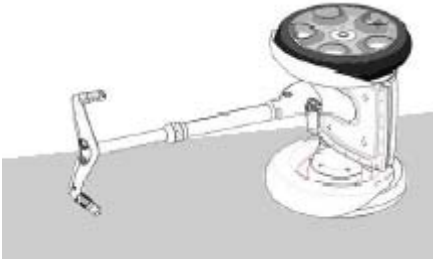

Remove all cargo bags.

Do not attempt to separate tire from wheel.

Check tire air pressure regularly. Inflate i and e Series tires to 15 psi (103 kPa) and p Series tires to 22 psi (152 kPa). Insufficiently inflated tires can reduce mileage, affect performance, and break wheels. Over-inflated tires reduce suspension performance and tire traction.

Check tightness of wheel nuts for safe operation. Torque wheel nuts to 50.0 N-m.

### Directions:

#### Removal Instructions

1. Remove the wheel nut with a 16mm deep socket wrench. Hold the wheel from rotating and turn the wrench counter clockwise. (This may require considerable force.)



2. Strike down on the outside edge of the tire with a rubber mallet to unseat the wheel hub taper. (This may require multiple attempts and considerable force, as the wheel hub is tight to the gearbox taper.)
3. Remove the wheel.

#### Installation Instructions

(Note: Replace any fasteners you remove when performing this installation with the new fasteners included in the replacement kit, unless reinstalling existing wheel).

4. Clean the gearbox taper and the wheel hub taper with alcohol wipes.
5. Place the new wheel hub opening over the gearbox shaft; rotate the wheel while pressing down until the wheel seats.
6. Thread on the new wheel nut and torque to 50 N-m.

## Replacing the Mat

**Tools Required:** none

### Before you begin:

Make sure Segway HT is shut down and not plugged into an AC outlet.

If Segway HT is an e Series, you must first remove lower cargo bags and structure.

### Directions:

1. Lift Mat off Platform. For i and e Series models only, pull both “ears” of the Mat inward, out of fender channels.
2. Before installing Mat, make sure top of Platform and bottom of Mat are clean, dry, and free of debris.
3. Place new Mat on Platform and press down.

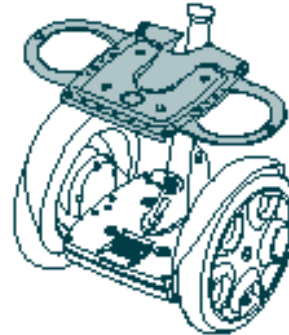

4. For i and e Series models only, press ears back into the fender channels.

## Securing or Replacing the Front Trim

**Tools Required:** none

### Before you begin:

Make sure Segway HT is shut down and not plugged into an AC outlet.

### Directions:

1. To remove the trim, pull from the bottom and lift up.
2. If you are replacing the trim, peel the old hook-and-loop fastener pad from the CSB, and install the new adhesive-backed hook-and-loop fastener pad.
3. Line up the hook-and-loop fastener. Match the two tabs on the top of the front trim with those on the CSB and lower trim back into place.
4. Use thumb pressure in areas where trim is still loose.

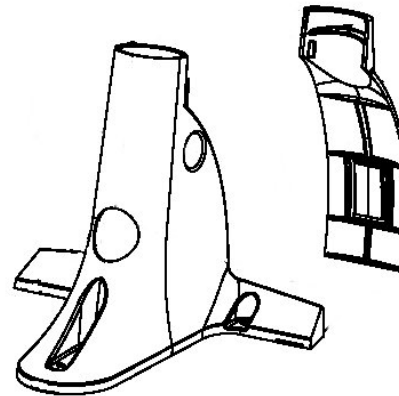

## Replacing the Fender

**Tools Required:** T-15 or T-20 six lobed wrench (depending on fastener size), 16mm deep socket wrench, torque wrench capable of 1.5 N-m to 50 N-m, plastic or rubber mallet, alcohol wipes

### Before you begin:

- > Make sure Segway HT is shut down and not plugged into AC.
- > Place a carpet or pad on the floor, to protect the wheel when you tip the Segway HT onto its side.
- > Tip the Segway HT onto its side so that the fender to be replaced faces up

### Directions:

#### Removal Instructions

1. Remove the Tire/Wheel Assembly—see “Replacing a Tire/Wheel Assembly” on page 76.



2. For i and e Series models only, pull both “ears” of the Mat inward, out of fender channels.
3. Remove the six fender screws using the appropriately sized (T-15 or T-20) six lobed wrench.

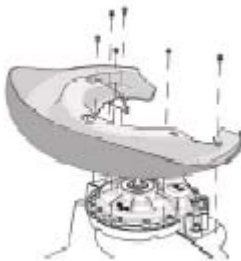

4. Pull up on the front side of the fender and flex the fender away from the gearbox.
5. Remove the fender from the gearbox. (The fender is positioned around the gearbox and requires some twisting for removal.)

#### Installations Instructions

(Note: Replace any fasteners you remove when performing this installation with the new fasteners included in the kit)

6. Install the fender making sure to flex it around the gearbox. When seated properly, the fender will be held in place by the gearbox and the 6 screw locations will align with the screw locations in the chassis and gearbox.
7. Thread in the 6 new fender screws and torque to 1.5 N-m (do not over tighten). There is one hole in the fender that does not line up with a threaded hole in the gearbox. Do not install a screw here.
8. Install the Tire/Wheel Assembly—see “Replacing a Tire/Wheel Assembly” on page 76.
9. For i and e Series models only, press ears back into the fender channels.
10. Tip your Segway HT up onto its wheels.

## Replacing a Parking Stand (i Series only)

**Tools Required:** 4mm hex wrench, T-15 or T-20 six lobed wrench (depending on fastener size), 16mm socket wrench, alcohol wipes, plastic or rubber mallet, torque wrench

### Before you begin:

Tip the Segway HT onto its side so that the outside of the left wheel lays flat against a clean smooth surface.

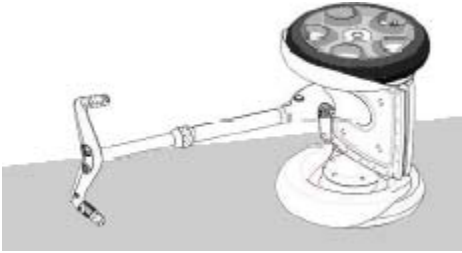

### Directions:

1. Remove the Tire/Wheel Assembly—See “Replacing a Tire/Wheel Assembly” on page 76.
2. Remove the Fender—See “Replacing the Fender” on page 78.

### Parking Stand Removal Instructions

3. Remove the two Parking Stand screws using a 4mm hex wrench.
4. Disengage the Parking Stand lever from the Mat.
5. Remove the Parking Stand.

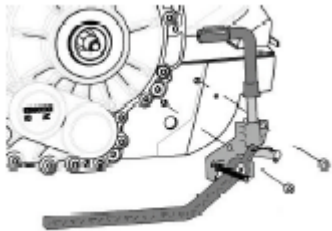

Replace any fasteners you remove when performing this installation with the new fasteners included in the replacement kit

### Parking Stand Installation Instructions

6. Set the new Parking Stand on the side of the Chassis.
7. Align the two screw holes (ensuring that the Parking Stand bracket is flush against the Chassis).
8. Thread in the two new hex head screws and torque to 0.5 N-m with a hex wrench (do not over tighten).
9. Install the Fender— See “Replacing the Fender” on page 78.
10. Install the Tire/Wheel Assembly— See “Replacing a Tire/Wheel Assembly” on page 76.
11. Tip your Segway HT up onto its wheels and test the operation of the new Parking Stand.

## Replacing the Handlebar/Control Shaft Assembly

**Tools Required:** 4mm or 5 mm hex wrench (depending on the size of the fastener), torque wrench

### Before you begin:

Make sure Segway HT is shut down and not plugged into an AC outlet. It is unsafe to perform this procedure while you are charging your Segway HT.

### Directions:

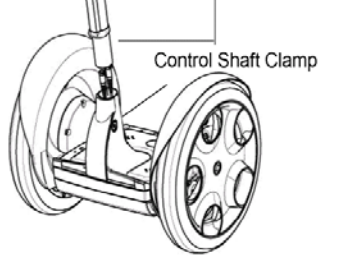
1. Loosen the Height Adjustment Collar and slide the upper portion of the Control Shaft fully into the lower portion of the Control Shaft.
  2. Gently tighten the Height Adjustment Collar.
  3. Using the appropriate size (4mm or 5mm) hex wrench, loosen (but do not remove) the Control Shaft Clamp Bolt.
  4. Carefully lift the Handlebar/Control Shaft upwards and out of the Control Shaft Base far enough to expose the two cord connections.
  5. Separate the cords at the connections by depressing the locking tabs and gently pulling the cords apart.
  6. Inspect the pins inside each connector to make sure they are not bent or broken. Bent or broken pins could result in a Safety Shutdown. If you observe bent or broken pins, contact Segway Customer Operations.
  7. Reattach the two connectors. The connectors are keyed and color-coded to indicate the proper matching. Connect the yellow cord from the Handlebar/Control Shaft to the yellow cord in the Control Shaft Base. Connect the black cord from the Handlebar/Control Shaft to the black cord in the Control Shaft Base. Make sure the locking tabs engage. When you make these connections, you should hear and feel a click.
- 
8. Loosen the Height Adjustment Collar and carefully extend the Control Shaft to approximately one-half its full extended length (to reduce the risk of pinching the cords when reinstalling the Handlebar/Control Shaft in the Control Shaft Base).
  9. Tighten the Height Adjustment Collar.
  10. Insert the Handlebar/Control Shaft fully into the Control Shaft Base, making certain the cord connections remain attached, the cords are not pinched, and the rubber O-ring (near the bottom of the Handlebar/Control Shaft) is tight against the top of the Control Shaft Base.
  11. Lay the Segway HT down forward onto the Handlebar to properly align the Handlebar parallel with the front of the Platform.
  12. Use the appropriate size (4mm or 5 mm) hex wrench to tighten the Control Shaft Clamp Bolt to torque 6.8 N-m.

You may wish to disconnect the Handlebar/ Control Shaft from the Control Shaft Base. This may make it easier to transport the Segway HT. To remove the Handlebar/Control Shaft Assembly, follow the procedure described in the previous steps 1 through 5. The Handlebar/ Control Shaft is then disconnected from the Control Shaft Base. To reconnect the Handlebar/Control Shaft to the Control Shaft Base, follow the procedures described in steps 6 through 13.

## Replacing the Fixed Grip

**Tools Required:** 5.0mm hex wrench, torque wrench

### Before you begin:

- > Make sure Segway HT is shut down and not plugged into an AC outlet.
- > Do not use the Parking Stand to support the Segway HT while performing this procedure. The Parking Stand is not designed to withstand the forces that may be generated. Instead, support the Platform with an object so that you have easy access to the Handlebar.

### Directions:

#### Removal Instructions

1. Remove the fastener at the end of the Handlebar on the Fixed Grip side using a 5mm hex wrench.
2. Slide the Fixed Grip off of the Handlebar.

Replace all old components, including fasteners, with the materials included in this kit

3. Orient the new Fixed Grip so that the key on the inside opening aligns with the groove on the Handlebar, and slide the grip all the way on.

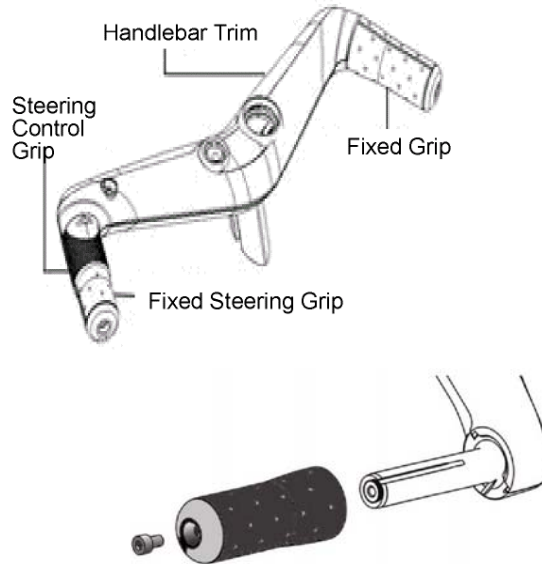

4. Thread in the new fastener and torque to 6.8 N-m with a 5mm hex wrench.

## Replacing the Steering Grip

**Tools Required:** 5.0mm hex wrench, torque wrench

### Before you begin:

- > Make sure Segway HT is shut down and not plugged into an AC outlet.
- > Do not use the Parking Stand to support the Segway HT while performing this procedure. The Parking Stand is not designed to withstand the forces that may be generated. Instead, support the Platform with an object so that you have easy access to the Handlebar.

### Directions:

#### Removal Instructions

1. Remove the fastener at the end of the Handlebar on the Steering Grip side using a 5mm hex wrench.
2. Slide the Fixed Steering Grip and Steering Control Grip off of the Handlebar.

#### Installation Instructions

Replace all old components, including fasteners, with the materials included in this kit

3. Orient the new Steering Control Grip so that the raised contour is facing up and toward the front of the Segway HT, and the rib is facing straight down.

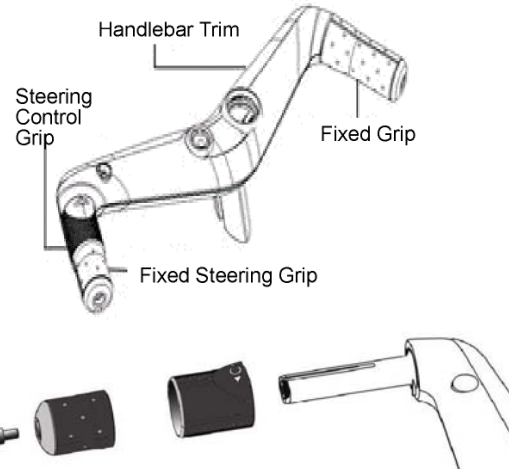

4. Slide the Steering Control Grip all the way on.
5. Orient the Fixed Steering Grip so the key on the inside opening aligns with the groove on the handlebar, and slide the grip all the way on.
6. Thread in the new fastener and torque to 6.8 N-m with a 5mm hex wrench.

## Replacing the Charge Port Cover

**Tools Required:** flathead screwdriver, alcohol wipes, tweezers

### Before you begin:

Make sure Segway HT is shut down and the AC power cord is removed.

**CAUTION!** The Charge Port Cover is an environmental seal and must be replaced if damaged.

### Directions:

#### Removal Instructions

1. If necessary, remove the original Charge Port Cover from the Control Shaft Base (CSB) by gently prying the bottom of the cover with a flathead screwdriver.
2. Moisten a clean rag with solvent and wipe away adhesive residue from the Control Shaft Base.

#### Installation Instructions

3. Use tweezers to peel the adhesive release sheet from the pink rubber seal on the back of the new Charge Port Cover.
4. Orient the new Charge Port Cover so that the opening lines up with the AC power receptacle. (The rubber flap hinge from the bottom.) The tabs of the cover flap must be within the groove on the back side of the Charge Port Cover.

5. Press the Charge Port Cover onto the AC power receptacle until it snaps into place. (You may need to squeeze the left and right edges of the cover together while inserting it into the opening.)
6. Press firmly around the entire surface of the cover until it is securely locked in place. Be sure that the rubber seal is in contact with the metal of the Control Shaft Base all the way around the Charge Port Cover.

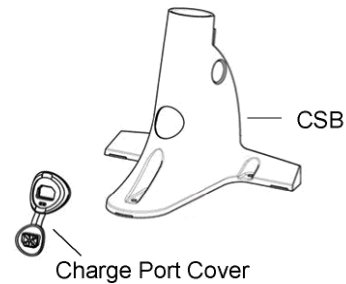

## Replacing the Control Shaft Clamp

**Tools Required:** 4.0mm hex wrench, torque wrench

The two rubber wedges found in the Control Shaft Base (CSB) hold the Control Shaft in place. Loosening the bolt will allow removal of the Control Shaft. Tightening the 4mm bolt holds the Control Shaft in place and prevents it from rotating.

If the Control Shaft rotates even when the wedge clamp is tightened, then the Control Shaft bearing may have broken. If the inner Control Shaft rotates within the outer Control Shaft, this bearing is most likely broken and needs replacement by a trained service technician. Control Shaft clamp parts must always be replaced as a kit.

### Before you begin:

- > Make sure the Segway HT is shut down and not plugged into an AC outlet.
- > Remove any accessories from the Control Shaft.
- > Make sure the Segway HT is stabilized while you work on it.

### Directions:

1. Remove the Handlebar/Control Shaft Assembly from the CSB (see "Replacing the Handlebar/Control Shaft Assembly" on page 80).
2. Push the Control Shaft Clamp parts out from inside of CSB.
3. Push in new the Control Shaft Clamp parts with the threaded clamp on the right side. Orient the curved sides toward the center.
4. Install Control Shaft Clamp bolt (M5 x 0.8 x 45 socket head cap 4mm hex) on the left side
5. Make sure the Handlebar is straight by laying the Segway HT onto its forward with Handlebar on ground.
6. Tighten the Control Shaft Clamp bolt to 6.8 N-m.
7. Install the Handlebar/Control Shaft Assembly from the CSB (see "Replacing the Handlebar/Control Shaft Assembly" on page 80).

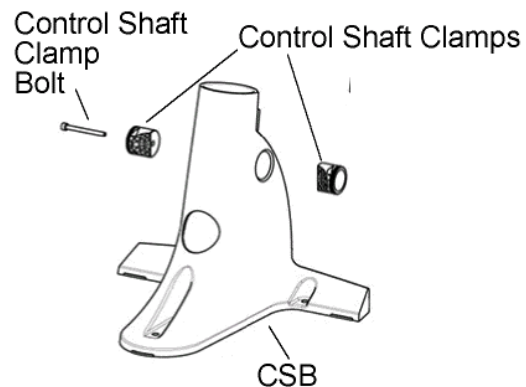

## Installing an Upper Frame and Bag Cargo Structure

**Tools Required:** 2.5mm and 4mm hex wrenches, torque wrench

### Before you begin:

- > Make sure Segway HT is shut down and not plugged into an AC outlet.
- > Do not use the parking stand to support the Segway HT while performing this procedure. The parking stand is not designed to withstand the forces that may be generated. Instead, position the Segway HT so that you have easy access to the front of the Handlebar and Control Shaft.

### Directions:

1. If present, remove the two button head screws located on the bottom of the handlebar using a 4mm hex wrench.



2. Align the holes in the wire frame with the screw locations in the bottom of the handlebar so that the frame is on the front side of the control shaft.
3. Install the two button head screws through the holes in the wire frame and into the bottom of the handlebar using a 4mm hex wrench and torque to 7.5 N-m.

4. Install the clamp on the control shaft just above the height adjustment collar with the hook facing forward and up.
5. Note: Replace any fasteners you remove when performing this installation with the new fasteners included in the kit.
6. Slide the clamp up to the wire frame so that the wire frame rests in the hook.
7. Install the clamp screw and with a 2.5mm hex wrench torque to 1.5 N-m. (The gap between the halves of the clamp should be about 4mm.)
8. Lightly tap the wire frame so that it snaps in the hook of the clamp.
9. Drape the cargo bag over the handlebar so that the Display and Key Port are not obstructed.



10. Secure the hook and loop straps around the wire frame at the bottom and sides of the bag.

## Post-repair Checklist

### Display and Audibility Test

- LCD – display (Make sure the display properly shows startup test; and Segway HT turns on in Power Assist Mode without an error message in the display.)
- Sound (Make sure Segway HT produces a beep when a Key is used to power on the Segway HT.)
- Charging indicator check at the Control Shaft Base (see “Charging Indicators” on page 70.)

### Operational Test

- Check for obstructions under the Mat.
- Check the Control Shaft for tightness.
- Power the Segway HT on and off two times.
- Power on the Segway HT to test the Rider Detect Sensors. (Make sure that the display does not indicate that a Rider Detect Sensor is engaged at startup, and that the Segway HT does detect a Rider Detect Sensor is depressed when you place your foot on the Mat.)
- While holding the Platform of the Segway HT level, press and release the Mode Button to switch from Power Assist Mode to Balance Mode, look for the green smiling face in the display.
- Ride the Segway HT.
- Move forward and backward.
- Check Power Assist Mode both forward and backward.
- Check E-Stand functionality (e Series only).

### Safety Check

- Check that the fasteners are in place, secure, and tightened correctly.
- Check the wheels for wear, tightness, and correct tire air pressure.
- Check that the Mat is intact, secure, and free of debris.
- Check the Grips for tightness; make sure Steering Control Grip returns to center.
- Check to make sure that no part is damaged or loose.

## Lifting and Loading Your Segway HT

Use safe and appropriate loading/lifting techniques when lifting your Segway HT. Make sure the Segway HT is powered off prior to lifting. It is recommended that two people work together to lift the Segway HT, with each placing a hand on the Control Shaft (under the Height Adjustment Collar) and a hand under the Platform. Lift with your legs, not your back. Never lift the Segway HT by its tires, fenders, or wheels because your hand could become caught between the tire and the fender, resulting in injury.

## Packing Your Segway HT for Shipment

Keep your original box and packing materials. Make sure you pack the Segway HT in the reverse order from how you unpacked it. Shipping it in a non-Segway box can result in damage.

## Summary

Review these processes in preparation for the Operation and Maintenance Assessment exercise.

- > Bring the Segway HT to an open area using Power Assist Mode
- > Note the Battery Pack Charge level.
- > Check the Control Shaft for tightness/rotation and tighten Control Shaft Clamp bolt if necessary.
- > Check the tire air pressure.
- > Perform brief external inspection of Segway HT including:
  - Tires
  - Wheels
  - Battery Packs
  - Fenders
  - Mat
  - Handlebar orientation
- > Remove and replace Control Shaft.
- > Remove and replace Battery Packs.
- > Ride the Segway HT.
- > Turn off the Segway HT.
- > Plug your Segway HT into AC power
- > Confirm that the Segway HT is charging.
- > Deploy the Parking Stand (i Series only).
- > Unplug your Segway HT and retract the Parking Stand
- > Turn on the Segway HT.

## > Session 7 Demonstrating and Guiding a Ride

<b>Who.</b>	Entire class.
<b>What.</b>	Learn how to keep new riders safe when they take their first ride.
<b>Where.</b>	Classroom/open space
<b>Method.</b>	Workshop

### Timing

Introduction and Objectives, Demonstrating the Segway HT and Guiding a Ride	25 min
Summary	5 min
<b>Total Time</b>	<b>30 min</b>

### Introduction

In this session, you will learn how to introduce a new rider to the Segway HT by allowing him/her to experience its operation by a guided ride.

### Objectives

Upon completion of this session the participant (the “Guide”) should be able to:

- > Maintain control of the rider and Segway HT at all times
- > Cope with challenging situations safely
- > Select an environment free of hazards
- > Explain the steering control of the Segway HT
- > Help a new rider step on and off the Segway HT
- > Stabilize a rider who is uncomfortable or oscillating
- > Stop a rider who is not able to maintain control or is aggressive
- > Stop a rider who is overconfident and under skilled
- > Anticipate the rider’s style and customize your approach
- > Provide a new rider with a safe and enjoyable first ride

### Topics

The following topics will be covered in this session:

- > Tips and Techniques
- > Demonstration and Guided Ride Workshop
- > Summary

### Tips and Techniques

When providing a riding experience, the Guide may have only a short time to communicate several key concepts to the rider. Depending on the scope of the guided ride, the Guide must determine the level of detail to include. Use your judgment to determine the scope of the ride and information you are providing.

Keep in mind that your goal is to provide a **safe** and **enjoyable** experience, which exemplifies the **ease** and **utility** of the Segway HT.

The Guide should:

- > Define his/her role - “Your safety during this short demonstration is **my** responsibility”
- > Define the rider’s limits - “Please don’t get on or off until I tell you it’s OK”
- > Define the Segway HT’s limits - “Don’t get on the Segway HT unless there is a green smiling face”, “it’s not magic- you can make it fall”, “it needs traction to balance” etc.

## Demonstrating a Ride

What constitutes a good demonstration ride?

What are the different types of demonstrations and guided rides you will encounter (see below.)?

What determines the type of experience you will provide?

Type of Experience	Type 1: “One of many rides”	Type 2: “About 2 minutes”
Information to Cover	<ul style="list-style-type: none"> <li>&gt; Demonstrate the entire operational model from retracting the Parking Stand, turning the Segway HT on with Beginner Key, changing from Power Assist to Balance mode, stepping on and off, etc.</li> <li>&gt; Explain all functions of the Segway HT including Steering Grip, Mode Button, Display, and Rider Detect Sensors.</li> <li>&gt; Rider steps on, moves forward, backward, stops and turns. Rider may negotiate cones or try another terrain. Rider then steps off.</li> <li>&gt; 3-10 minute guided ride</li> <li>&gt; Show power assist.</li> </ul>	<ul style="list-style-type: none"> <li>&gt; Demonstrate the Segway HT by showing how it moves forward, backward, stops and turns.</li> <li>&gt; Explain the Steering Grip and Display. Answer any other questions, but don’t offer information.</li> <li>&gt; Rider steps, moves forward, backward, stops and turns, rides once around an oval, then steps off.</li> <li>&gt; 1-3 minute guided ride</li> <li>&gt; Begin next ride.</li> </ul>

## Guiding a Ride

Always dismount the Segway HT, turn it off, and turn it back on with a **Beginner** Key prior to giving a guided ride.

**Guide Tips:**

- > Hold the Handlebar firmly and brace yourself every time the rider steps on or off the Segway HT.
- > When you are confident that the rider has control, release the Handlebar slowly, but stay very close.
- > Be prepared to hold the Handlebar. Always remain within an arm’s length of the Control Shaft or Handlebar.
- > Block access to the Platform physically or verbally, until you are ready to assist the rider as she steps on
- > Watch the rider’s foot placement – riders who can’t control fore/aft motion may have their feet in the wrong place.
- > Explain the steering control – “This is how you steer.” Show the rider a smooth motion, contrast with an abrupt motion.
- > Make sure the rider is not looking down - “Focus on something at eye level.”

## Challenging Situations

The Guide may encounter the following challenging situations. How will you avoid these challenges?

- > Stepping On or Off Unexpectedly
- > Pitch Oscillation
- > Improper Foot Placement
- > Turns Immediately
- > Going for the Curb

### Stepping On or Off Unexpectedly

This situation happens when the Guide is not ready for the rider to step up onto or down off of the Platform. The danger is oscillation, moving backward or forward unintentionally, and loss of confidence.

#### How to avoid it:

- > Always have complete control of the Segway HT and provide clear concise instruction on when a rider is allowed to step on or off the Platform.
- > Block the Platform either with your hand or your body while giving instruction. Then open up the Platform indicating that the rider can step on and that the Instructor is ready. Conversely, hold the Segway HT as soon as you anticipate that the rider will dismount. Remain hyper-aware that the rider may dismount unpredictably.

### Pitch Oscillation

Pitch Oscillation occurs when the rider first steps up onto the Platform. The Segway HT moves forward and backward in a rapid movement. The danger is loss of balance or traction, resulting in injury or loss of confidence.

#### How to avoid it:

- > Always hold the Control Shaft or Handlebar firmly as a rider steps on the Segway HT. Brace your feet in a way that you can stabilize the Segway HT.
- > It is VERY important that the rider has a solid hold on the Handlebar (not a white-knuckled clutch, but enough to maintain balance) when s/he steps on. In a violent pitch oscillation, holding the Grips keeps the rider safely on the Segway HT while the Guide stabilizes the Segway HT.

**Tip:** If you have a rider who oscillates, you can request that he step down off the Segway HT completely, and then step on again. Some Guides have found that the second time on the Segway HT, the rider does not oscillate.

### Improper Foot Placement

Improper foot placement may result in a new rider having difficulty staying still. Sometimes, the Segway HT rolls backward or forward and the rider can't understand why the Segway HT is moving. The danger is hitting an obstacle or person, and fear of not being able to remain stationary.

#### How to avoid it:

- > Always check the rider's foot placement once she steps up onto the Segway HT. Both feet should be in the center of the Platform or placed in such a way that the rider can comfortably remain stationary.
- > The Guide should be firmly holding the Handlebar, with feet braced in case a forceful rider steps on in the wrong place.

## Turns Immediately

Sometimes a new rider will turn immediately without completely understanding the concept of the Steering Grip. The new rider may either turn immediately when stepping up onto the Segway HT or turn unexpectedly during the demonstration.

### How to avoid it:

- > Communicate to the new rider to not turn the Steering Grip when stepping onto the Segway HT. The rider should maintain a light grip on the Handlebar.
- > Explain to the new rider that s/he should turn the Steering Grip in a slow controlled manner.
- > Demonstrate how the Segway HT turns, by twisting the Steering Grip for the rider.

## Going For The Curb

Sometimes a new rider will turn suddenly and head directly toward an oncoming obstacle such as a curb, wall, car, person, etc.

### How to avoid it:

- > Stay close to a new rider during the Guided ride. Always position yourself between a rider and an obstacle.
- > Keep pace with the rider at all times. It is not necessary to actually be touching the Control Shaft or Handlebar every second, but the Guide needs to be able to quickly grasp the Segway HT and stop it.
- > Determine if the rider was disregarding the instructions or was accidentally heading for the obstacle. If the rider was purposely disregarding the instructions, repeat, **“Your safety during this demonstration is my responsibility.”**

## Demonstration and Guided Ride Workshop

This workshop is divided into two exercises:

- > Demonstrate how to operate and ride (based on Type 1 experience)
- > Guide a Ride

Work in groups of two/three practicing all the guiding techniques we discussed.

**Option:** At the end of the workshop, the instructor will ask each Guide to perform exercises listed above. The instructor will be the rider. The goal is for the guide to conduct a demonstration and guided ride that keeps the rider safe, and provides an enjoyable experience.

## Demonstrate the Segway HT

The Guide will demonstrate and explain the following:

1. Make sure the rider has helmet. Explain that properly adjusting your helmet is important.
2. Unplug the Segway HT
3. Retract the Parking Stand
4. Power on. Use Beginner Key for the first ride, to maintain control. No need to explain the different Keys at this point.
5. Check battery charge level, and explain the segments around the perimeter of the display.
6. Adjust Control Shaft to the proper height
7. Stand beside the Segway HT while in Power Assist Mode, and demonstrate the forward/reverse motion induced by twisting the Steering Grip

8. Show how, by tapping the Mode Button, one changes between Power Assist Mode and Balance Mode
9. Demonstrate the left/right motion induced by twisting the Steering Grip while in Balance Mode
10. Demonstrate the proper form for stepping onto the Platform
11. Demonstrate all maneuvers that the rider will be performing
12. Demonstrate the proper form for stepping down off the Platform
13. Turn off Segway HT

## Guide a Ride

Invite the first rider to stand next to the Segway HT.

Block the Platform to restrict the rider's ability to step onto the Platform prematurely, and/or explain that riders are not to step onto the Platform until expressly instructed. The Guide can position himself in front of or beside the Segway HT but **MUST** have a firm grip on the Handlebar or Control Shaft.

1. Explain the Segway HT parts
2. Guide rider to hold the right Handlebar and feel the motion of the Segway HT in Power Assist Mode and in Balance Mode
3. Instruct the rider to, while s/he maintains a hold on the Handlebar, tap the Mode Button to set Power Assist Mode, then tap again to set Balance Mode
4. Ask if the rider can see the different display icon (should be green background, smile face, wind), and feel the Segway HT balance itself.
5. Solidly hold Handlebar/Control Shaft, and instruct rider to:
  - a. Hold Grips with both hands
  - b. Step onto Platform, first with one foot. Feel the Segway HT balance with one foot before stepping on with the other.
  - c. Choose a point in the distance to maintain a sense of perspective
  - d. Have rider step onto Platform with other foot. Maintain firm hold of the Segway HT.
6. While the Guide maintains a hold, instruct the rider to gently roll slowly forward and backward 3-5 feet both directions, until s/he find "neutral" on the Segway HT. Explain that this is the position used to hold the Segway HT still. Evaluate when the rider has enough control that the Guide can release her grip but stay close enough to grab the Segway HT if needed.
7. Evaluate the rider's ability: Determine whether the Guide should twist the Steering Grip for the rider or let him twist it.
8. Instruct the rider to GENTLY twist the Steering Grip without moving forward or backward. The rider should turn a full 360° in place, both directions.
9. **Explain:** "Now, we'll take a turn around the track. Show the rider the route you want him/her to follow. **Say:** "I want you to remember three things every time you ride: Calm, Controlled, Courteous." (This is the mantra we would like running through the mind of every rider on a Segway HT!)
10. Walk/jog beside the rider and direct him to maintain speed control, as he rides beside you. Reinforce proper stance, foot position and relaxed muscles. Ideally, you will not have to remind the rider to grin!
11. Ask the rider to stop
12. Stand in front of Segway HT, and grip the Control Shaft or Handlebar firmly
13. Instruct rider to step down off the Platform, without pulling it back into himself.

Maintain a position of control at all times by walking beside the Segway HT within a bent-arm's length of the Handlebar, or the Control Shaft.

## Summary

Review the following tips for a conducting a successful guided ride:

It is common for the rider to oscillate. If this happens, do the following:

- > Ask the rider to try to relax and concentrate on standing still, as you hold the Segway HT still.
- > Ask the rider to look ahead if s/he is looking down
- > Assess whether the Segway HT is pushing toward you or away:
  - **Toward** you indicates that the rider is leaning too far forward, or that the rider's feet are too far forward. Have her shift weight, feet, or both backward.
  - **Away** from you indicates the opposite. See above.

Emphasize that the rider controls the movement with his/her feet and body in relation to the point where the tires touch the ground (contact patch).

Explain that “pitch oscillation” is common because the brain is not used to having something else balance for them.

Encourage the rider to trust the Segway HT, and relax his/her hands, shoulders, arms and knees.

Check foot position and ensure that feet are placed in such a way that s/he can stand still. (Ideal foot position depends on the rider's body type, not necessarily on centering the foot. In some cases, the rider's feet may be positioned further forward or back, or even staggered on the Mat in order to achieve “neutral” motion.)

Check rider posture – bent knees, relaxed shoulders, light hands, looking ahead.

Observe hands – instruct rider to use “light hands” or a “gentle grip.” A rider may begin turning the Segway HT automatically as a result of his/her “tight grip” on the Steering Control. The Guide must hold the Segway HT firmly so it doesn't move forward or backward, and coach the rider to stop turning by lightening her grip.

Remember, the overall goal of a guided ride is to provide a safe and enjoyable riding experience.

## > Session 8 Course Summary

<b>Who.</b>	Entire class
<b>What.</b>	Review key points
<b>Where.</b>	Classroom
<b>Method.</b>	Interactive lecture, experiential learning, Q&A

### Timing

Ride Outside (Optional)	45-60 min
Review Goals	15 min
Evaluation Forms Filled Out by Participants	15 min
<b>Total Time</b>	<b>1 hour, 30 min</b>

### Topics

The following topics will be covered in this session:

- > Ride Outside
- > Review Goals
- > Review these Need to Knows

### Ride Outside (Optional)

Take riders on a follow-the-leader excursion outside. Try to choose a setting that, **if it is not the actual** riding environment, has similar terrain features. Ask riders to put on their helmets.

Lead the group, pointing out any terrain features that would be challenging, or any unpredictable circumstances that could arise, such as transitioning terrain from flat to bumpy or bumpy to flat.

Expose rider to the types of terrain and obstacles to look for, so that they can use their best judgment in negotiating the outside world. Below are some examples of challenging surfaces and possible hazards to point out:

- > Grass with hidden rocks, holes, or curbs
- > Gravel or sand, especially on a slope
- > Puddles
- > Runoff or washout trough
- > Wet grass, soft ground, mud, ice
- > Narrow sidewalks
- > Any obstacle that can slow or catch the outside of your wheel or bags on an e Series (door jam, curb stone, fire hydrant)
- > Low overhangs (signs, trees, door jam)
- > Turns on slopes
- > Metal grates and plates, railroad tracks, manhole covers, sewage drains
- > Pipes sticking up
- > Hoses, extension cords, wet leaves, small branches, and any item that can move beneath your tires and cause traction loss
- > Drop offs, especially on the blind side of a door
- > Loose carpets/throw rugs
- > Screws, glass, nails
- > Cars backing up or running crosswalks/lights
- > Animals and children

Avoid blind spots and use caution around building corners, driveways, parked cars, parking garages, and opening doors on cars or buildings.

## Review Goals

Being aware of, anticipating, and responding correctly to the environment, your own capabilities and limitations, and those of the Segway HT will enable you to ride in a safe and responsible manner.

- > Operate the Segway HT in a controlled and responsible fashion.
- > Recognize environments for which the Segway HT has been designed.
- > Respond to warnings and alerts from the Segway HT.
- > Perform maintenance and service procedures.
- > Discuss Riding Assessment and Safety Review Booklet

You are now at the Conscious Competent stage. You know what you know. From here, it takes practice and time to transition into the Unconscious Competent stage.

## Evaluations

Please complete the evaluation forms, and hand those in, along with your Proficiency Checklist from the Riding Assessment and Safety Review Booklet.

End class by asking if there are any other questions, and asking participants to complete the evaluation forms and Rider Proficiency Checklist. Collect both.

## > Session 9 Written and Riding Assessments

- Who.** Split class into two groups, and then reconvene for review of Written Assessment.
- What.** Half the class will perform the agility track assessment, while the other half completes the written assessment.
- Where.** Classroom/agility track
- Method.** Assessment of skills and knowledge retention
- Option.** Do not cover this information during the class. Instead, hand it out as a take-away for participants to assess their own skill levels. If you choose this option, **disregard** the Instructor guidelines, and direct participants to complete the tasks after the class.

### Timing

Introduction and Objectives	5 min
Written Assessment	30 min
Riding Assessment	30 min
Summary, Review the Written Assessment, Q&A	10 min
<b>Total Time</b>	<b>1 hour, 15 min</b>

### Overview

This session covers the Written and Riding Assessments. The instructor may ask you to complete this before, during or after the training.

Turn the page to begin the Written Assessment.

Written Assessment will be conducted in the classroom. Riding Assessment will be conducted on the agility track. Divide the group into two, and simultaneously run both sessions.

### Instructor Guidelines for Written Assessment

**Cover** the following guidelines for the entire class:

- > **Complete** the Written Assessment within 30 minutes.
- > **Read** directions carefully.
- > **Choose** the **best** answer if multiple answers seem right.
- > **Choose** only **one** answer.

Instructor will then:

- > **Divide** the class.
- > **Ask** participants to turn the page to begin the Written Assessment

## Written Assessment

Please choose only one answer for each question. Chose the **best** answer to each question.

1. Which of the following displays indicates Power Assist Mode: **(d)**

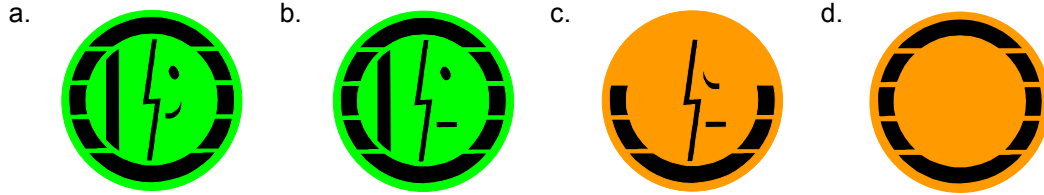

2. Which of the following best describes Power Assist Mode? **(b)**

- Whistle, and the Segway HT will follow you around like a puppy
- Power is on, but balancing mechanism is not enabled. Use Steering Grip to power the wheels forward and backward
- Power is off. Use Steering Grip to power the wheels forward and backward.
- Power is on. Balancing mechanism is enabled. Use Steering Grip to turn right and left. OK to step on and ride.

3. Which of the following displays indicates Balance Mode: **(a)**

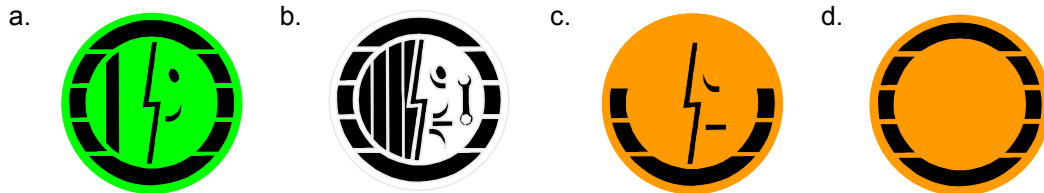

4. Which of the following best describes Balance Mode? **(d)**

- Whistle, and the Segway HT will follow you around like a puppy
- Power is on, but balancing mechanism is not enabled. Use Steering Grip to power the wheels forward and backward
- Power is off. Use Steering Grip to power the wheels forward and backward.
- Power is on. Balancing mechanism is enabled. Use Steering Grip to turn right and left. OK to step on and ride.

5. Which of the following displays indicates that the Segway HT is shutting down: **(c)**

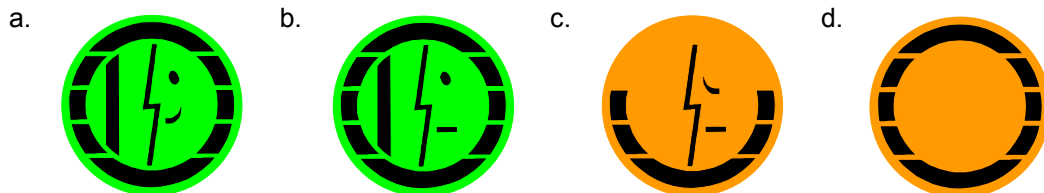

6. Indications that the Segway HT is in Balance Mode are: **(a)**

- Green smiling face, wheels move when you move the Handlebar
- Orange smiling face, Steering Grip is inoperative
- Gray display, moving the Handlebar results in no wheel movement
- Red frowning face

7. The following alerts occur when a rider is on the Segway HT, and the Battery Packs reach full depletion: **(c)**
- The display flashes orange and the Segway HT stick shakes
  - The display turns a steady orange and the Segway HT slows down to zero speed
  - The display flashes red. If riding continues, the Segway HT performs a Safety Shutdown
  - The display goes blank and the Segway HT whistles
8. The following happens when the Segway HT battery is too low to power on: **(d)**
- The Segway HT starts but will not go into Balance Mode
  - The Segway HT does not show any display
  - The straight-face appears with a red display
  - The bottom battery segment appears with a red display
9. The proper order for riding is:  
First, unplug the Segway HT and retract the Parking Stand if applicable, then... **(b)**
- Start the Segway HT, step onto the Platform, ride, step off
  - Start the Segway HT, change to Balance Mode, step onto the Platform, ride, step off
  - Start the Segway HT, change to Power Assist Mode, step onto the Platform, ride, step off
  - Step onto the Platform, ride, step off, shut down
10. Which of the following actions causes the Display to flash a red frown, then become orange with no face: **(a)**
- Platform/Control Shaft was not at the correct angle when entering Balance Mode
  - Mode Button was pressed for too long
  - Rider pressed Mode Button while on Segway HT
  - You will never see this

11. When might you see the display on the right: **(a)**
- At start up
  - At shut down
  - When putting the Segway HT into Balance Mode
  - When changing from Balance to Power Assist Mode



12. When might you see the display on the right: **(d)**
- When the Segway HT will not enter Balance Mode
  - When you power down with the Mode Button
  - When trying to power on with the wrong key
  - When the Segway HT is in a state of reduced performance



13. The display on the right indicates that the: **(a)**
- Steering grip is off-center to the left at start up
  - Steering grip is inoperable
  - Steering grip is off-center to the right at start up
  - Left front Rider Detect Sensor is depressed at startup

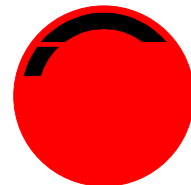

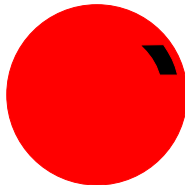
14. What should you do if you see the display on the right? **(d)**
- Plug in your Segway HT
  - Unplug your Segway HT
  - Step onto the Platform
  - Remove your foot from the Platform
- 
15. The Segway HT does **all** of the following, except: **(b)**
- Actively balance forward and backward
  - Provide dynamic side-to-side stability
  - Limit your speed based on the Key being used
  - Turn in place
16. The Balance Sensor Assembly primarily assists the Segway HT in:**(c)**
- Steering the Segway HT left and right
  - Steering control while in Power Assist Mode
  - Dynamic Stabilization—balancing the rider forward and backward
  - All of the above
17. The Segway HT has a zero turning radius which is the direct result of: **(a)**
- The wheels turning in opposite directions
  - The microprocessors in the power base
  - High center of gravity
  - Redundant systems
18. To maintain lateral stability when turning, you should: **(a)**
- Lean in the direction of the turn
  - Lean in the opposite direction of the turn
  - Stand as upright as possible
  - Increase speed through the turn
19. When riding over uneven terrain, it is important to maintain:**(d)**
- High speed over bumps
  - A stiff body to maintain your center of gravity
  - Tight grip on the Handlebar for control
  - Bent knees in order to absorb shock
20. When riding along and approaching a large obstacle which might only affect one tire, the safest way to maneuver is to:**(d)**
- Put weight on the foot above obstacle and lean toward obstacle
  - Put weight on the foot away from obstacle and lean toward obstacle
  - Put weight on the foot above obstacle and lean away from obstacle
  - Ride around the obstacle
21. You should charge NiMH Battery Packs: **(c)**
- Only when the display shows three or less battery segments
  - Only when the display shows one flashing battery segment
  - Every time that it is convenient, and when possible for 6 hours or more
  - Only when the display shows zero battery charge remaining
22. To **remain** stationary facing downhill on a slope, you need to: **(b)**
- Lean forward
  - Position your center of gravity over the contact patch on the tires
  - Position your center of gravity over the front Rider Detect Sensors
  - Step off the Segway HT, because it is impossible to remain stationary on a hill

23. A rider powered on her Segway HT after charging it overnight. She checked the battery charge level on the Display and noted that all segments around the perimeter were displayed. She put her Segway HT into Balance Mode, stepped on, and rode a short distance from her house to the top of her driveway. After riding down her steep driveway for less than a minute, her Segway HT slowed down automatically by tilting the Platform backward/tilting the Handlebar into her torso. She recognized this behavior as the Speed Limiter. After determining that she had powered on with the Open Environment Key and that she was riding at only about half the maximum speed, she reviewed her Segway HT user materials, and determined that: **(b)**
- She was pressing the Mode Button while riding down the hill, and should release the Mode Button while riding
  - Because regenerative braking created more energy than could be stored in the already-full Battery Packs, the Segway HT activated the speed limiter.
  - The Segway HT slowed itself down because there were traction issues
  - The Segway HT was still plugged in
24. If you are in a building with an elevator, and you want to ride your Segway to the bottom floor, you should: **(a)**
- Ride your Segway on an elevator when there is room and you are not negatively impacting others
  - Disassemble your Segway prior to taking it with you on an elevator
  - Always take the stairs with your Segway HT in Power Assist Mode
  - Never take your Segway HT on an elevator
25. The Segway HT has an onboard universal input charger. To charge the Segway HT in countries with 220v instead of 110v, (and 50/60Hz) you need: **(b)**
- An external converter to change the voltage
  - A plug adapter that fits the non-USA outlet
  - Nothing, just plug into the non-USA outlet
  - You can't charge the Segway HT except in the USA
26. To check the charging status on the rear Battery Pack: **(a)**
- Observe the right-hand Charging Indicator LED on the Control Shaft Base
  - Observe the left-hand Charging Indicator LED on the Control Shaft Base
  - You can't discern charging status by the LEDs
  - Unplug the Segway HT, and observe the Charging Indicator LEDs
27. When riding and you feel or hear a stick shake, your first reaction should be to: **(b)**
- Press the Mode Button
  - Slow down
  - Call technical support
  - None of the above
28. If the Handlebar is crooked, you should: **(c)**
- Twist it back into place
  - Lay the Segway HT on the floor to brace the Handlebar, and twist it back into place
  - Loosen Control Shaft Clamp bolt, lay the Segway HT on the floor to orient the Handlebar, push into place, and tighten Control Shaft Clamp bolt
  - Loosen and tighten the Height Adjustment Collar until you can move the Handlebar back into place

29. When riding and you see a green straight face, your first reaction should be to: **(b)**
- Press the Mode Button
  - Slow down
  - Stop, Drop and Roll
  - None of the above
30. If you are standing beside your Segway HT, while it is in Balance Mode, and it moves quickly forward a few feet (meters) from where you stepped off, what will happen? **(a)**
- The Segway HT stick shakes
  - The Segway HT will move forward indefinitely if you release it
  - The Segway HT will stop immediately and turn 360°
  - None of the above
31. You have ridden the Segway HT until your NiMH Battery Packs were fully depleted. How long do you need to charge the Segway HT to complete all four stages of the charging cycle: **(d)**
- Approximately 30 minutes
  - Approximately 2 hour
  - Approximately 4 hours
  - Approximately 6 hours or more
32. If you feel the Handlebar tilt into your torso while you are riding, this is because the Segway HT is alerting you to: **(a)**
- Slow down
  - Change to Power Assist Mode
  - Avoid a metal grate
  - All of the above
33. The best way to take a Segway HT up a set of stairs is: **(b)**
- Put Segway HT in Power Assist Mode, stand below, push up the stairs
  - Put Segway HT in Power Assist Mode, stand above, pull up the stairs
  - Keep Segway HT in Balance Mode, stand below, guide up stairs
  - Ride the Segway HT up the stairs
34. After you plug in your Segway HT, it is important to see if the Segway HT is receiving a charge by looking at the: **(d)**
- Display on the Handlebar
  - Battery Packs beneath the Segway HT
  - Orientation of the Platform
  - Charging Indicators in the Control Shaft Base
35. How many Battery Packs are providing power while riding the Segway HT: **(c)**
- 0
  - 1
  - 2
  - 3
36. Choose the best response to this statement: The Segway HT will continue to operate until the second Battery is depleted, if one Battery Pack fails or is completely depleted: **(c)**
- Yes, this is true
  - No, it will continue to run only for approximately 10 minutes
  - No, it will continue to run only for approximately 10 seconds
  - No, the Segway HT will shut down immediately

37. If the Segway HT is trying to communicate a safety critical message, the rider would expect to: **(d)**
- Hear the message
  - Feel the message
  - See the message
  - All of the above
38. The reason that the Segway HT sometimes limits your speed is: **(c)**
- The Segway HT capabilities have been reduced for environmental reasons
  - You reached top speed for the existing conditions
  - Either a or b
  - None of the above
39. An indication that the Segway HT has reduced performance when you are riding at 8mph is: **(d)**
- The Segway HT will limit your speed
  - The Platform tilts aft
  - The turning control is slowed
  - Both a and b
40. If you experience a Safety Shutdown while moving forward at 10 mph (16 km/h), you should know this because: **(d)**
- The Platform pitches aft to slow your speed
  - The Segway HT vibrates (Stick Shake Warning)
  - The Display shows red and the Segway HT beeps
  - All of the above
41. A green backlight with a smiling face in the Display indicates: **(c)**
- The HT is in Power Assist Mode, you should not step on
  - The HT is turning off, it is OK to turn it back on
  - The HT is in Balance Mode, you can step on
  - The tires are oscillating

Match the number in the illustration to the description below:

42. To straighten the Handlebar, loosen the **Control Shaft Clamp bolt** \_\_\_\_\_ (7) that holds this clamp together,
43. Tap the **Mode Button** \_\_\_\_\_ (1) to change from Power Assist to Balance Mode or hold for 2-3 seconds to power down.
44. Disconnect the **Control Shaft** \_\_\_\_\_ (8) from the Base, to check the Control Shaft Cord connectors.
45. If your Tire/Wheel assembly wobbles, check the **Wheel Nut** \_\_\_\_\_ (6)
46. Insert the Control Shaft into the **Control Shaft Base** \_\_\_\_\_ (4) after you have checked your Control Shaft cords.



47. Twist the **Steering Grip** \_\_\_\_\_ (2) left and right to turn, when you are in Balance Mode, or to power the wheels forward and backward when you are in Power Assist Mode.
48. When you are stepping on, hold onto the **Fixed Grip** \_\_\_\_\_ (9) and the non-twisting end of the Steering Grip.
49. Adjust the height of the Handlebar by loosening the **Height Adjustment Collar** \_\_\_\_\_ (3), raising or lowering the Control Shaft, and then tightening the Height Adjustment Collar.
50. To remove a **Battery Pack** \_\_\_\_\_ (5), tip the Segway HT to provide access beneath the Platform, unfasten the four 3mm screws, and slide the Battery Pack straight off the chassis.

**Answer Key**

- |     |          |     |          |
|-----|----------|-----|----------|
| 1.  | <b>d</b> | 26. | <b>a</b> |
| 2.  | <b>b</b> | 27. | <b>b</b> |
| 3.  | <b>a</b> | 28. | <b>c</b> |
| 4.  | <b>d</b> | 29. | <b>b</b> |
| 5.  | <b>c</b> | 30. | <b>a</b> |
| 6.  | <b>a</b> | 31. | <b>d</b> |
| 7.  | <b>c</b> | 32. | <b>a</b> |
| 8.  | <b>d</b> | 33. | <b>b</b> |
| 9.  | <b>b</b> | 34. | <b>d</b> |
| 10. | <b>a</b> | 35. | <b>c</b> |
| 11. | <b>a</b> | 36. | <b>c</b> |
| 12. | <b>d</b> | 37. | <b>d</b> |
| 13. | <b>a</b> | 38. | <b>c</b> |
| 14. | <b>d</b> | 39. | <b>d</b> |
| 15. | <b>b</b> | 40. | <b>d</b> |
| 16. | <b>c</b> | 41. | <b>c</b> |
| 17. | <b>a</b> | 42. | <b>7</b> |
| 18. | <b>a</b> | 43. | <b>1</b> |
| 19. | <b>d</b> | 44. | <b>8</b> |
| 20. | <b>d</b> | 45. | <b>6</b> |
| 21. | <b>c</b> | 46. | <b>4</b> |
| 22. | <b>b</b> | 47. | <b>2</b> |
| 23. | <b>b</b> | 48. | <b>9</b> |
| 24. | <b>a</b> | 49. | <b>3</b> |
| 25. | <b>b</b> | 50. | <b>5</b> |

# Riding Assessment

## Instructor Guidelines for Riding Assessment

- > **Instruct** the participants to choose a helmet and a Segway HT, and meet you at the agility track.
- > **Assess** each rider as s/he negotiates the agility track. (It is OK to direct them through the course, but don't coach them on riding skills.)
- > **Observe** if a rider hits a cone or does not negotiate any terrain in a controlled and graceful manner. If this does happen, ask the rider to redo that segment of the track.
- > **Direct** the rider to begin again if h/she has trouble with multiple segments.
- > **Remind** riders that they have 30 minutes.

This list of exercises will be useful for practicing your riding skills. You should be able to complete each task while:

- > Maintaining control of the Segway HT
- > Demonstrating sound decision-making ability regarding his/her own capabilities
- > Utilizing Segway HT capabilities
- > Performing a clean ride without hitting cones

Basic Rider Tasks	Redo	Acceptable	Excellent
Retract Parking Stand prior to startup (i Series only)			
Use Key effectively (don't push down or damage contacts)			
Change from Power Assist Mode to Balance Mode			
Check Display to ensure Segway HT is in Balance Mode, and Battery Pack charge is adequate			
Step on the Segway HT			
Execute smooth, controlled, leaning turns around cones			
Traverse bumpy terrain			
Traverse pothole			
Perform a controlled stop in predefined area			
Descend small curb using step method (to 6") or controlled drop (3" or less)			
Ascend and descend ramp– stop halfway			
Use Power Assist Mode (a) down steep curb, (b) across crooked sidewalk or (c) up/down stairs			
Negotiate long, narrow pathway without hitting any cones			
Step off the Segway HT			
Turn off Segway HT, deploy Parking Stand (i Series only)			
Recognize and respond to Safety Feature Alerts			

**Notes:**